

M – 142i

Multifunction Calibrator

Operation Manual

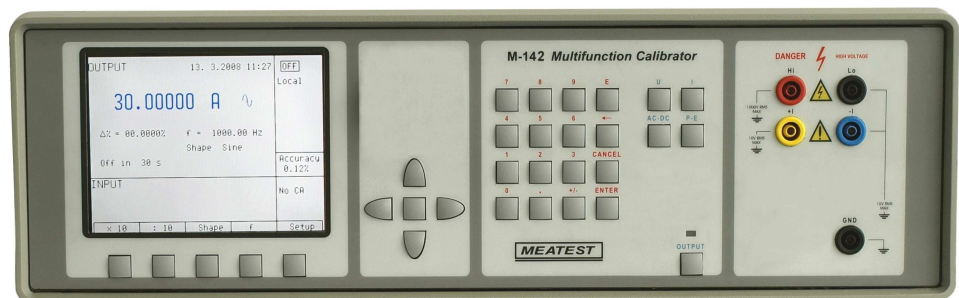

Content

Operation Manual	1
Basic Information	5
Preparation for operation	6
Inspecting package contents, selecting the installation location	6
Power-on	6
Warm-up time	6
Replacement of fuse	6
Safety precautions	7
Description of controls	8
Front panel	8
Rear panel	12
Control of the calibrator	13
Selection of function	13
Setting the value of output signal	13
Setting relative deviation	14
Change of value by factor of ten	15
Connection / disconnection of output terminals	16
Setting the frequency	16
Generation of calibrated voltage	17
Generation of calibrated current	19
Simulation of temperature sensors	20
Setup menu	22
Calibration mode	26
Error messages	33
Functional description of the calibrator	35
Calibrator's maintenance	40
Verification test	42
System control	47
RS232 bus properties	47
Command syntax	47
Examples of use	53
Calibration of measurement instruments	53
Multimeters.....	53
Thermometers.....	54

Specification **55**
Accessories..... **58**

Basic Information

M-142i is a multifunction calibrator, to be used primarily as a standard for calibration laboratories. It can be used for calibration of any measuring instrument which measures voltage, and current. The calibrator includes a function which simulates thermocouple temperature sensors.

Basic features of the calibrator include: generation of calibrated DC and AC voltage in the range of 0 μ V to 1000 V, DC and AC current in the range of 0 μ A to 30 A (50 μ A to 1000 A when using a 50-turn coil). Maximum precision of the calibrator is 0.0015 % for DC voltage, 0.03 % for AC voltage, 0.013 % for DC current and 0.055 % for AC current. Maximum frequency range is 20 Hz to 100 kHz.

Simulation of thermocouple temperature sensors can be used to calibrate thermometers and heat sensing units. The calibrator allows the simulation of all common R, S, B, J, T, E, K, N type of thermocouples. Compensation of cold junction of thermocouple is achieved by entering the respective temperature using the calibrator's keyboard. The accuracy of simulated temperature sensors depends on the value and type of sensor and ranges from 0.4 $^{\circ}$ C to 4.3 $^{\circ}$ C.

The calibrator includes many other features which facilitate easy use. For example relative deviation from set value of the output, currently displayed uncertainty of the output signal, calibration and internal testing procedures. The concept of calibrator control and indication of its status is based on flat luminiscent display, which provides all necessary information. The calibrator is controlled by opening menus on the display and selection from menus. Frequently used functions are assigned direct-control keys. The calibrator comes with RS-232 serial line, which allow the calibrator to be controlled from a PC.

The calibrator can easily fit within calibration systems featuring CALIBER/WinQbase software support.

ATTENTION !
The calibrator generates life-threatening high voltage.

The calibrator can only be used in line with this
Manual.

Preparation for operation

Inspecting package contents, selecting the installation location

Basic package includes the following items:

- Multifunction calibrator
- Power cord
- Spare fuse T4L250/T, T8L250/T
- Operation manual.
- Test report
- Test cable 1000V/30 A 2 pcs
- RS 232 cable

The calibrator should be powered by 230/115 V – 50/60 Hz mains. It is a laboratory instrument whose parameters are guaranteed at 23 ± 2 °C. Before powering on the instruments, place it on a level surface. Do not cover the vents at the bottom side and the fan opening at the rear panel.

Power-on

- Before connecting the calibrator to the mains, check the position of the mains voltage selector located at the rear panel.
- Plug one end of the power cord into the connector located at the rear panel and connect the other end of the power cord into a wall outlet.
- Switch on the mains switch located at the rear panel. Flat display is lit.
- The calibrator performs internal hardware checks for 5 seconds.
- After the tests conclude, the calibrator resets to its reference state, i.e. the following parameters are set:

Function	DC voltage
Range	20 V
Set value	10 V
Output terminals	OFF

Note. The calibrator resets to its reference status in case of power switching off and reconnection.

Warm-up time

The calibrator works after it is switched on and the initial checks complete. Specified parameters are only guaranteed after the instrument warms up for 60 minutes. During this period, the instrument cannot be calibrated. The display shows “cannot access the calibration” message if calibration is attempted during this period.

Replacement of fuse

The calibrator includes a fuse located in the mains connector at the rear panel. Replace the fuse as follows:

- Switch off the calibrator
- Remove the end of power cord from the mains connector at the rear panel.
- Insert the blade of a flat screwdriver into the opening cut in the mains voltage selector and pull out the fuse holder.
- Remove the fuse and replace it with new fuse of the same rating.

Safety precautions

The instrument has been designed in Safety Class I according to EN 61010-1. The design reflects the requirements of A2 amendment of the standard.

Safety is ensured by the design and by the use of specific component types.

The manufacturer is not liable for the damage caused by modification of the construction or replacement of parts with non-original ones.

Safety symbols used on the equipment



Warning, reference to the documentation

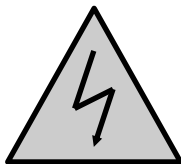

Warning - risk of electric shock



Danger - high voltage

Description of controls

Front panel

The front panel of the calibrator includes a flat luminiscent display, control buttons and output terminals. The following picture shows the control part of the front panel.

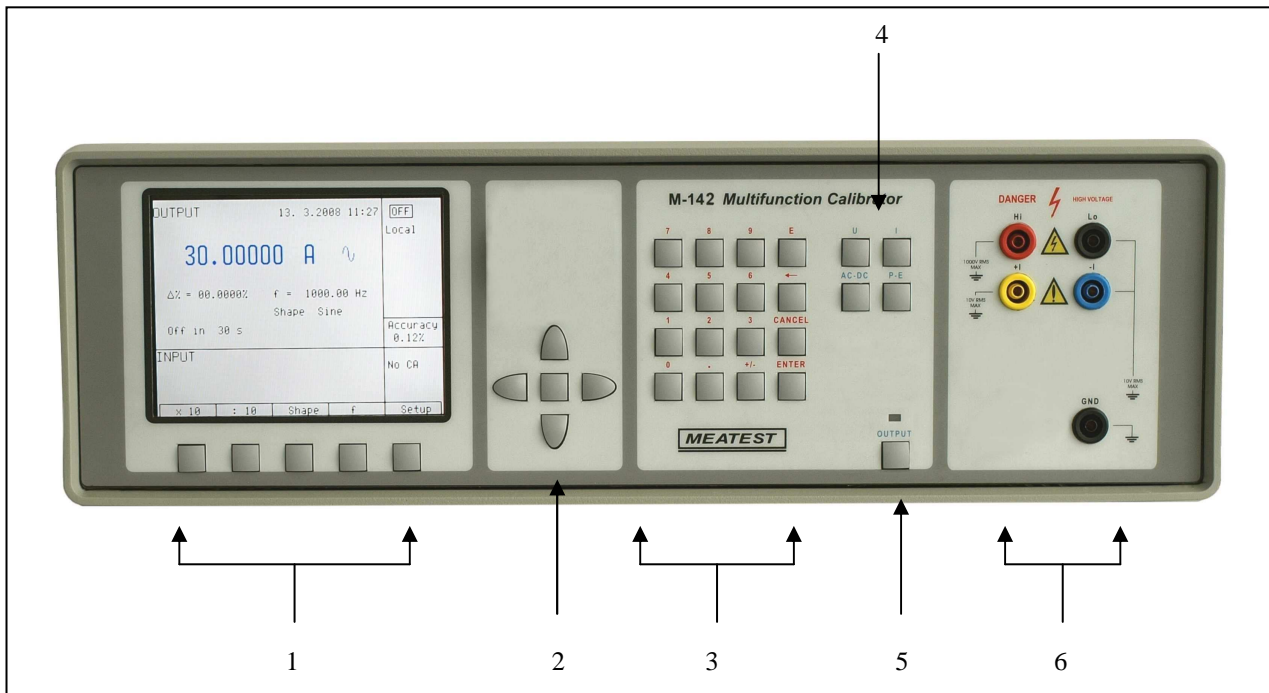

1 Display buttons

There are five buttons below the display, whose meaning changes depending on the contents of the display. These buttons usually call-up the MENU, allow range change, step, logging of values etc.

2 Cursor buttons

Using these buttons, the cursor can be controlled within allowed limits on the display. The keyboard includes two buttons (<, >) which allow the cursor to be set to the required position at the display. The cursor can be moved to the left or right. These buttons are usually used to step through the options and to move from one option to another or between the menu levels. Numeric values can be set in some control modes as well. In these cases, the buttons marked (\wedge , \vee) allow the user to increase or decrease the number at the cursor button.

The central button is used to confirm the selection (ENTER), or to SELECT from the menu.

3 Numeric keyboard

The keyboard allows the entry of numeric values on the display. The central button is used to confirm the selection (ENTER). CANCEL button can be used to cancel the entry.

4 Function buttons

Function buttons can be used to call-up the functions of the calibrator directly. The following buttons are provided:

<i>function</i>	<i>button</i>
DC voltage	U / DC
AC voltage	U / AC
DC current	I / DC
AC current	I / AC
simulation of temperature sensors	T

After the function mode is changed, the parameters of the respective function are restored. If the respective function was never used, the calibrator resets to its reference values. Reference values for individual functions are listed below.

<i>function</i>	<i>value</i>	<i>parameters</i>
DC voltage	10V	--
AC voltage	10 V	f = 1000 Hz
DC current	100 mA	--
AC current	100 mA	f = 1000 Hz
simulation of temperature sensors	100 °C	TC type R
cold junction temperature of TC sensors	23 °C	Type R

5 Output terminal button

OUTPUT button is used to connect the output signal of the calibrator to the output terminals. The connection is confirmed by symbol on the display.

6 Output terminals

Output signal of the calibrator is connected to the output terminals. Current ranges are connected to **+I / -I** terminals. All other functions (voltage, temperature sensor simulation) are connected to **Hi / Lo** terminals.

GND terminal is connected to the chassis of the calibrator. It is connected to the ground terminal of the mains plug. Using the SETUP MENU of the calibrator, the output terminals of the calibrator can be grounded as well. Grounding is done internally by connecting Lo and GND terminals using a relay. This circuit design is suitable for most calibrations, when the object (multimeter) being calibrated is floating.

Front panel display shows all information provided by the calibrator, e.g. set parameters of the signal, error messages, setup information. The display is divided to several information sections.

7 Display

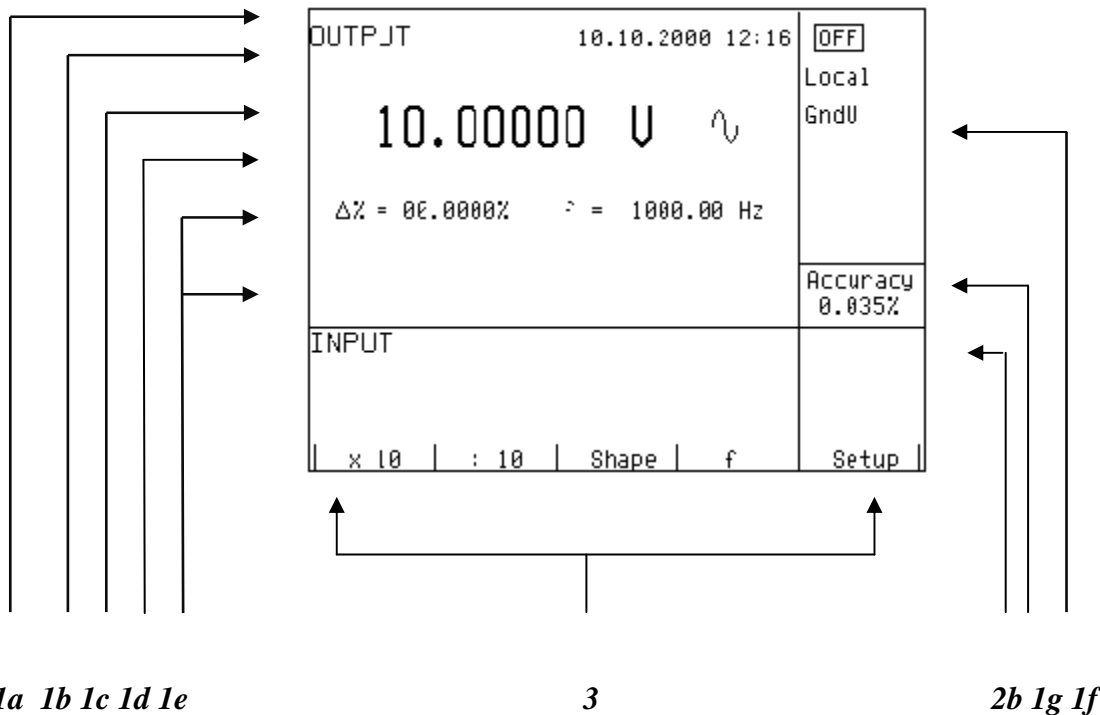

The display is divided to three horizontal sections:

1. OUTPUT section

This section displays the set-up values of generated signals and the data related to the calibrator status. The section includes the following types of data:

a) Information line

- designation of display section: OUTPUT
- error messages. The messages appear when an attempt is made to set up an invalid state of the calibrator, if analogue circuits of the calibrator are overloaded or if a communication error occurs when the calibrator is controlled using GPIB bus.
- real date and time, if its display is set-up in the setup menu.

b) Auxiliary data

This line displays the total value of output signal if a non-zero relative deviation is set.

c) Main data

This line displays the main data of the output signal and the unit of measurement (using double size signs). The line also includes two symbols (**▼▲**) to define the actual position of the cursor during adjustment of the value. **<**, **>** buttons can be used to move the cursor and **^**, **v** buttons to change the value. (The value can be also changed using the potentiometer).

d) Monitoring line

This line displays the numbers entered using the numeric keyboard when the main data are set using the numeric keyboard. The information allows the entered information to be checked.

e) Minor data

There are two lines displaying the minor data of the output signal, especially:

- set relative deviation from main set value in %

- frequency (for DC voltage, current, power, energy functions)
- cold junction temperature of TC sensors and the selected type of TC sensor

f) *Information section*

The information section located in the right part of the display displays additional information related to the selected function:

- symbol of connected or disconnected output terminals.

At the same time, a LED located above the OUTPUT button is lit.

- information about remote/local control of the calibrator. If the calibrator is controlled remotely, REM is displayed. If the calibrator is controlled locally using the keyboard, LOCAL is displayed.
- information about the use of 50-turn coil (COIL x50) at the current output of the calibrator, if this feature is turned on using the SETUP menu.
- information about the type of connected cable adapter, if used
- information about the grounding method of output terminals: GND I, GND U as set up using the setup menu.

g) *Information about the uncertainty of the output signal*

This section displays the maximum error of the main value of the output signal. The value is calculated using the main specification listed in the User's Manual and it is displayed in %.

2. INPUT section

This section displays the values measured by the multimeter. It is not available in M-142i version.

3. Display buttons section

This line displays the symbolic descriptions which define the meaning of four related display buttons. The respective meanings are as follows:

<i>symbol</i>	<i>button function</i>	<i>note</i>
x 10	increase set value 10 x	
: 10	decrease set value 10 x	
+/-	reversed polarity of output voltage and current	only for DC U, DC I functions
Calib.	enter the calibration menu	
SETUP	enter the setup menu	
TC type	selection of thermocouple sensor type	only for T function
f	enter the frequency of the signal	only for U, I function

Rear panel

The rear panel of the calibrator includes ventilation holes, power cord socket with fuse, mains voltage selector, mains switch, IEEE 488 connectors for connection to GPIB bus and type plate with serial number.

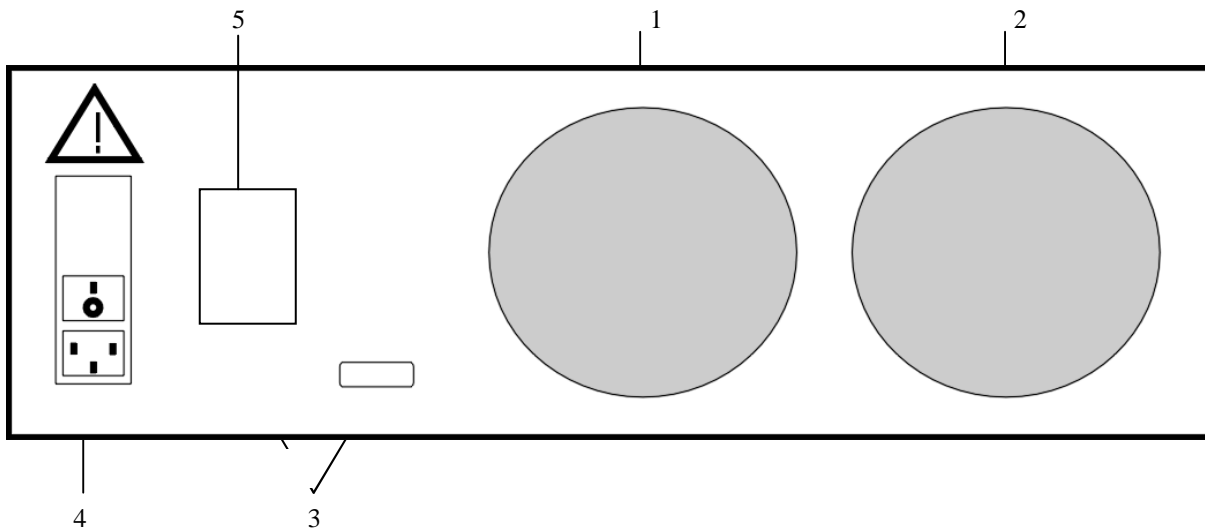

- 1 air inlet - forced ventilation
- 2 air outlet - forced ventilation
- 3 RS-232 connector
- 4 power cord socket with fuse, mains voltage selector, mains switch
- 5 type plate

Control of the calibrator

Selection of function

After the power is switched on and the initial checks complete, the calibrator resets to its reference status, i.e. DC voltage output with set value of 10 V and output terminals disconnected. The status of the calibrator can be changed using the buttons located at the front panel in one of the following ways:

1. Change of function by pressing one of direct function buttons

After pressing one of the U, I, DC-AC, T buttons, the calibrator switches to the desired function mode and resets to the reference or to the most recently used parameter setting.

2. Connection /disconnection of output terminals

After pressing the OUTPUT button, the output terminals of the calibrator are connected/disconnected.

3. Entry to the setup menu

After pressing the SETUP button, options of the SETUP MENU appear on the display and the display buttons allow the entry to the calibration mode (CALIB). Previous function is restored by pressing of EXIT display button.

Setting the value of output signal

All function modes allow several methods of setting the main value of the output signal:

Entry of the value using numeric keyboard

- use the numeric keyboard to select the desired value. After the first digit is entered, symbols of unit of measurements are displayed above the display buttons. The monitor line displays the symbols [_ _ _ _ _].
- the same entry can be started by pressing the central cursor button
- after the entry is complete (the value is displayed on the monitor line), press the display button below the desired unit of measurement (V, mV or μ V in the example below)
- the value is copied to the main display and the monitor line disappears.

OUTPJT	10.10.2000 12:19	[OFF]
10.00000 U \sim	: 5.236_____]	Local GndU
$\Delta\%$ = 00.0000%	f = 1000.00 Hz	Accuracy 0.035%
	Shape Sine	
INPUT		
μ V mV V		Exit

Entry of the value using cursor buttons

- press <, >, ^ or v button. The display now includes cursor marks which point to the active digit.
- ^ and v buttons can be used to change the active digit. <, > buttons can be used to change the position of the cursor marks
- to get to the default screen, press EXIT button or keep pressing the center cursor button until there is no [_____] under any value. All values can be set using the buttons or the potentiometer.

Reverse polarity

In DC voltage and DC current modes, the polarity of the output value can be reversed by pressing +/- display button. „-“ symbol appears in front of the main data value.

Setting relative deviation

All function modes of the calibrator except frequency mode allow a relative deviation of output value from the main data to be set using a separate display. Relative deviation is displayed in the “minor data” section of the display and is designated with „ $\Delta\%$ = 00.0000 % “ symbol. The relative deviation can be entered using one of the methods described above, e.g. using the numeric keyboard, cursor keys or the potentiometer.

Setting relative deviation using numeric keyboard

- keep pressing the center cursor button until [_____] symbols appear under the relative deviation value in the “minor data” section of the display
- enter the desired deviation and confirm the value by pressing “ % “ display button or by pressing ENTER on the numeric keyboard
- the auxiliary line below the main data on the display displays the total value of output signal including the unit of measurement
- the value of the signal at output terminals is: the value indicated by the main display + $\Delta\%$.

OUTPUT	10.10.2000 12:19	OFF
10.00000 U	~	Local GndU
$\Delta\% = 00.0000\%$ [0.15-----]	$f = 1000.00$ Hz Shape Sine	Accuracy 0.035%
INPUT		
%		Exit

Maximum relative deviation which can be entered is $\pm 30.000\%$.

The deviation can be positive or negative. If negative deviation is desired, press the display button labeled +/- . If positive deviation is then desired, press “ +/- “ button again. The polarity of the relative deviation can be reversed using the cursor buttons or the potentiometer as well.

Setting relative deviation using cursor keys

- keep pressing the center cursor button until [_ _ _ _ _] symbols appear under the relative deviation value
- press <, >, ^ or v button. The display now includes cursor marks which point to the active digit
- ^ and v buttons can be used to change the active digit. <, > buttons can be used to change the position of the cursor marks
- to get to the default screen, keep pressing the center cursor button until there is no [_ _ _ _ _] under any value, or press EXIT button. All values can be set using the buttons or the potentiometer.

If a non-zero relative deviation is set, the main data can be changed as well. The value of the output signal is always recalculated. If a zero relative deviation is set, the “minor data” section is not displayed.

Change of value by factor of ten

All functions of the calibrator allow the increase of the output value by 10 or reduction of the output value by 10. Such operation is equivalent to the change of internal range only in U, I modes. If the change results in overflow or underflow of calibrator’s range, an error message appears:

Value too large ! if the resulting value is too large

Value too small ! if the resulting value is too small

Connection / disconnection of output terminals

After switching on the output terminals are disconnected in all modes. Press the OUTPUT button to connect the output signal to the terminals. Information field on the display shows the following symbol  .

Press the OUTPUT button again to disconnect the output terminals. Information field on the display shows the following symbol  .

During mode change, output terminals are always disconnected. Output terminals are disconnected also when changing between voltage and current ranges or when changing between AC and DC ranges is performed.

If voltage over 100 V is set in the voltage mode, special algorithm must be followed to connect the output terminals. The algorithm is described in the „Generation of calibrated voltage“ chapter of this Manual.

Setting the frequency

Frequency can only be selected in AC voltage (ACU) mode, AC current (ACI) mode. Set value of frequency is included in the “minor data” section of the display.

Frequency change

- First select the AC voltage or AC current mode by pressing U (I), AC buttons or selecting the P-E mode using the display. Frequency value „f = xxx.xx Hz“ appears in the “minor data” section of the display. “ f “ symbol is displayed above one of the display buttons.
- After “ f “ display button is pressed, [_ _ _ _ _] symbols appear below the frequency value. Numeric keyboard can be used to enter the desired value. Press “ Hz “ or “ kHz “ to confirm the value. The value can be set using the buttons or the potentiometer.

OUTPJT		13.00000 U	10.10.2000 12:21	<input type="checkbox"/> OFF
10.00000 U				Local GndU
Δ% = 3E.0000%		f = 1000.00 Hz		
		shape sine		Accuracy 0.033%
INPUT				
Hz	kHz			Exit

If too large or too small value is entered, the calibrator displays the maximum (minimum) value which is allowed for the selected function.



Generation of calibrated voltage

The multifunction calibrator provides calibrated DC and AC voltage. Output terminals for voltage ranges are labeled “ Hi “ and “ Lo “ at the front panel. Depending on the setting of the calibrator, voltage up to 1000 Vef can be present at the terminals .

DC voltage range is 0 to 1000 V.

AC voltage range is 100 μ V to 1000 V.

Control in the voltage mode

- Press “U” button on the calibrator and then select AC or DC mode by pressing “DC-AC” button. The display shows the following data:
 - * main data of set voltage
 - * relative deviation
 - * uncertainty of output voltage
 - * frequency (when AC voltage is generated)
 - * total value of output voltage when non-zero relative deviation is set
- Set the desired value of voltage, including polarity when necessary, frequency and relative deviation. The signal is yet not connected to the output terminals. The information section of the display shows the symbol  which informs about the disconnection of output terminals.
- Press OUTPUT button.
- Information section of the display shows the symbol  .
- Calibrated voltage corresponding to set parameters is present at the output terminals.

Control sequence when output voltage over 100 V is selected

When output voltage over 100 V is selected, the information section of the display shows the symbol  which informs that a life-threatening voltage will be present at the output terminals. If the output terminals are currently connected, they will be disconnected when output voltage over 100 V is selected. OUTPUT button must be pressed to reconnect the output signal to the output terminals. After the OUTPUT button is pressed, an interrupted beep is sound, information section of the display shows the symbol notifying the user about the connection of the dangerous output signal to the output terminals.

Voltage, polarity, frequency, absolute and relative deviation can be set without the outputs being disconnected. The output terminals are automatically disconnected when changing between AC and DC ranges or when changing the function mode.

Overloading of terminals

If the output terminals are overloaded or short-circuited in the voltage mode, the calibrator disconnects the signal from the output terminals and reports „Overload U output“ error.

**ATTENTION DANGEROUS VOLTAGE**

When working with voltages over 50 V, rules for work with dangerous voltage must be adhered to.

Never touch the measurement circuit when voltage over 50 V is set and output terminals are connected!

**ATTENTION DANGEROUS VOLTAGE**

When the calibrator is controlled remotely, it is not possible to disconnect the output voltage using the buttons located at the front panel!

The calibrator must be first switched to local control mode by pressing the LOCAL button and then the output terminals can be disconnected or the mains switch must be switched off !

Generation of calibrated current

The multifunction calibrator provides calibrated DC and AC current. Output terminals for voltage ranges are labeled “ +I “ and “ -I “ at the front panel. The terminals can carry high current and are the only terminals to which the calibrated object can be connected. Depending on the setting of the calibrator, current up to 30 A_{rms} can be driven by the terminals.

DC current range is 0 to 30 A

AC current range is 1μA to 30 A

When 50-turn coil (option 140-50) is used, AC current range is 50μA to 1000 A.

Control in the current mode

- Press “I” button on the calibrator and then select AC or DC mode by pressing “DC-AC” button. The display shows the following data:
 - * main data of set current
 - * relative deviation
 - * uncertainty of output current
 - * frequency (when AC current is generated)
 - * total value of output current when non-zero absolute or relative deviation is set
 - * time after which the output terminals will be disconnected when the output current over 10 A is selected.
- Set the desired value of voltage, including polarity when necessary, frequency and relative deviation. The signal is yet not connected to the output terminals. The information section of the display shows the OFF symbol which informs about the disconnection of output terminals.
- Connect the load or short the output terminals labeled +I, -I.
- Press OUTPUT button.
- Information section of the display shows the symbol .
- Calibrated current corresponding to set parameters is driven by the output terminals.
- If COILx50 function is activated (see below - Setup functions menu), the optional 50-turn coil must be connected to output terminals. The calibrator can be used to calibrate 50 μA to 1000 A ammeters. The calibrator generates AC and DC current within the range up to 30 A.



CAUTION

If GND terminal is connected to Lo, -I terminals, it is prohibited to connect external load to GND / Hi or GND / +I terminals. Such connection can damage the calibrator.

Overloading the terminals

When external circuit connected to current output terminals is disconnected or there is higher voltage at the load than permitted, the calibrator disconnects the output terminals and displays „Overload I output“ message. The

same message can be displayed when 50-turn coil is used for AC current output at frequencies above 80 Hz. It depends on the set current and the type of ammeter connected.
 If the output terminals are disconnected due to time limitation of output current over 10 A, the calibrator displays „Current timeout !“ message.

Simulation of temperature sensors

The multifunction calibrator can simulate thermocouple temperature sensors. When thermocouples are simulated, a simulated voltage corresponding to set temperature, sensor type and temperature of cold end of thermocouple is connected to Hi - Lo terminals.

Temperature setting range: -250 to +1820 °C depending on simulated sensor type
 Sensor types: thermocouple K, N, R, S, B, J, T, E
 Temperature scale: ITS 90, PTS 68

Setting the temperature

- Press T button on the calibrator. The main value on the display is set temperature.
- The display shows the following data:
 - * main data of temperature in °C or K
 - * sensor type thermocouples: K, N, R, S, B, J, T, E
 - * cold junction temperature of thermocouple sensors labeled RJ
 - * set value of relate deviation in %, labeled $\Delta T = \text{xxxx.x } ^\circ\text{C (K)}$

the information section shows:

- * temperature scale type
- * uncertainty of simulated temperature value of selected temperature sensor type
- Set the main value of temperature using numeric keyboard, cursor buttons or potentiometer. Output terminals are disconnected, the information section of the display shows the symbol OFF which shows that output terminals are disconnected.
- Connect the object to be calibrated to Hi - Lo terminals.
- Press OUTPUT button.
- The display shows the symbol of connected output terminals.

OUTPUT	8. 6.2000 12:44	OFF	Local ITS90
0100.0 °C			
$\Delta T = 0000.0^\circ\text{C}$ RJ = 0023.0°C			
TC type T		Accuracy 0.4°C	
INPUT			
		TC type	Setup

Note: Load of output terminals is limited similarly to corresponding voltage or current ranges.

Entry of cold junction temperature

For thermocouples, the temperature of cold junction can be entered. The entry is performed by setting the RJ field in the auxiliary data section of the display.

- Select the thermocouple mode and keep pressing the center cursor button until [_ _ _ _ _] symbols appear under the (RJ = xxxx.x °C) value, if °C unit of measurement is used, or under (RJ = xxxx.x K) value, if K unit of measurement is used.
- Set the value using numeric keyboard.
- Confirm the value by pressing °C or K display button or by pressing ENTER.

OUTPUT		8. 6.2000 12:46	[OFF]
0100.0 °C		Local	
		ITS90	
ΔT = 0000.0 °C		RJ = 0023.0 °C	
TC type T		[28.5 _ _ _ _ _]	
		Accuracy	
		0.4 °C	
INPUT		V DC	
°C			Exit

Setup menu

The multifunction calibrator allows some other, less frequently used parameters to be set. Setup menu is used to set these parameters. Setup menu is opened by pressing SETUP display button. If output terminals are connected, they will be disconnected and the following display appears:

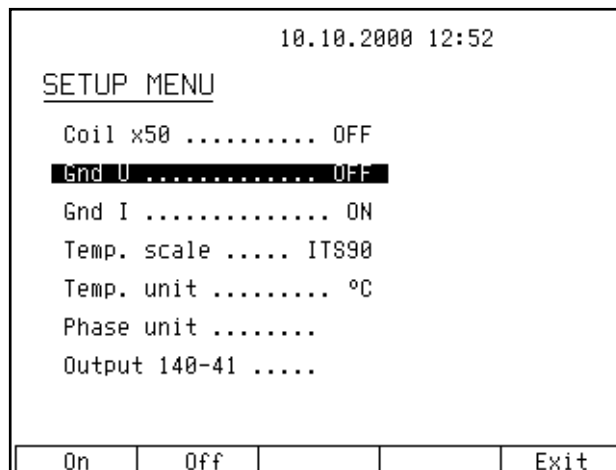

Use \wedge or \vee cursor button or the knob of the potentiometer to browse the menu options. Active option is always inverted and when changed, the descriptions of display buttons change as well. Display buttons show how the respective parameter can be set. Each parameter can be changed after the knob of the potentiometer is pressed. Press EXIT display button twice to save the parameters when the setting is completed. New settings are retained when the calibrator is switched off. Setup menu offers the following options:

1. *Coil x50 xx* **ON/OFF**

This parameter can be set on when 50-turn current coil is going to be used for clamp ammeter calibration. The coil multiplies the output current. OFF is set by the manufacturer.

2. *GND U xx* **ON/OFF**

This parameter connects Lo terminal to GND. In practice this means that Lo terminal is grounded. By pressing the display buttons, the terminal can be grounded or ungrounded. ON is set by the manufacturer, output terminal is grounded.

3. *GND I xx* **ON/OFF**

This parameter connects -I to GND. In practice this means that -I terminal is grounded. By pressing the display buttons, the terminal can be grounded or ungrounded. OFF is set by the manufacturer, output terminals are not grounded.

It is recommended to ground only the voltage channel GND U ON, GND I OFF, for all ranges except the generation of power or energy. If the meter to be calibrated has Lo terminal grounded, it is recommended to unground both outputs of the calibrator, GND U OFF, GND I OFF to exclude ground loops.

Note

If neither the calibrator's output, nor the meter's inputs are grounded, signal/noise ratio can arise at the calibrator's output.

4. **Temp.scale xx ITS90/PTS68**

This parameter allows the temperature scale for platinum resistance temperature sensors to be selected. Pressing the display buttons allows to switch between ITS90 and PTS68 temperature scales. ITS90 is set by the manufacturer.

5. **Temp.unit xx °C/K**

This parameter allows the temperature unit for simulation of temperature sensors to be selected. Pressing the display buttons allows to switch between °C and K. °C is set by the manufacturer.

6. **Phase.unit xx N/A**

Not available in M-142i version.

7. **Output 140-41 xx N/A**

Not available in M-142i version.

8. **Meter average xx N/A**

Not available in M-142i version.

9. **Interface xx N/A**

Not available in M-142i version.

10. **GPIB address xx N/A**

Not available in M-142i version.

11. **RS232 baud rate xx UP/DOWN**

Indicates the communication speed of RS232 bus. UP/DOWN display buttons can be used to select 150, 300, 600, 1200, 2400, 4800, 9600, 19200. Perfect communication with the PC requires equal values set at the PC and the calibrator.

12. **Handshake xx OFF/Xon-Xoff**

Indicates the communication handshake. Display buttons can be used to select OFF or Xon/Xoff. Perfect communication with the PC requires equal values set at the PC and the calibrator.

13. **Keyb.beep xx ON/OFF**

This parameter allows the acoustic indication of pressed buttons to be switched off or on. ON and OFF display buttons can be used to switch the indication off or on. ON is set by the manufacturer.

This parameter does not control the acoustic indication of output voltages over 100 V and identification of errors.

14. *Keyb.volume xx UP/DOWN*

This parameter allows the volume of acoustic indication to be set. UP and DOWN display buttons allow to set the value in the range of 00 to 15. The bigger the value, the louder sound. This parameter controls the volume of keyboard beep (if switched on), indication of output voltages over 100 V and identification of errors when controlling the calibrator.

15. *Brightness xx UP/DOWN*

This parameter sets the contrast of the display. UP and DOWN display buttons allow to set the value in the range of 00 to 15.

16. *Rotary change xx N/A*

Not available in M-142i version.

17. *Switch polarity xx N/A*

Not available in M-142i version.

18. *Switch activity xx N/A*

Not available in M-142i version.

19. *Cal.code 00000*

Entry of calibration code. Calibration code is a five-digit number, which must be entered to access the calibration mode. If the calibration code is set to "00000", this information is displayed in the Setup menu. Calibration code can be changed. New calibration code can be directly entered using numeric keyboard and confirmed by pressing ENTER. If non-zero calibration code is set, correct calibration code must be entered to access the calibration mode. Non-zero calibration code is not displayed further on the display.

The purpose of the calibration code is to prevent unauthorized users from changing the calibration of the instrument.

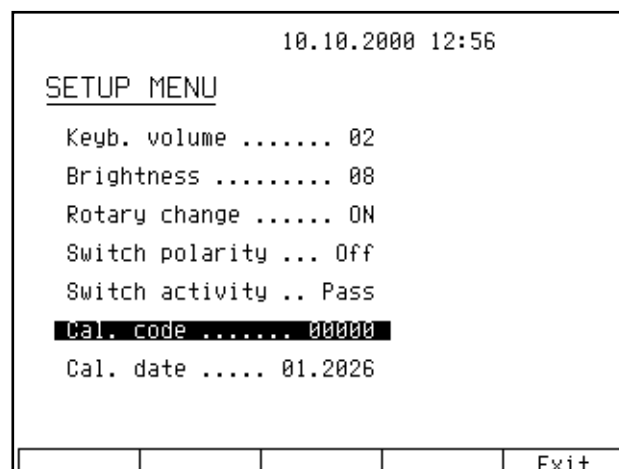

Note

It is advisable to write down actual calibration code if changed. If you forget the calibration code, you have to send the calibrator to the manufacturer.

20. **Cal.date xx.yyyy**

Displays the date of last calibration of the calibrator (month/year). The parameter cannot be changed, as it is automatically recorded when leaving the calibration mode.

21. **Serial No xxxxxx**

Displays the serial number of the calibrator. The parameter cannot be changed.

22. **Time xx:yy**

Displays real time. The parameter can be changed using HOUR UP, HOUR DO, MIN UP, MIN DO. display buttons.

23. **Date xx.yy.zzzz**

Displays real time. The parameter can be changed using DAY UP, MONTH UP, YEAR UP, YEAR DO display buttons.

24. **Time on display xx ON/OFF**

If set to ON, time and date are displayed in the upper part of the display. If OFF is set, time and date are not displayed. ON is set by the manufacturer.

Calibration mode

The multifunction calibrator includes a calibration procedure, which allows calibration of the calibrator. Zero point and slope of the characteristics of individual generation and measurement ranges are set during the calibration in predefined order. The calibration can only be controlled using the buttons and menu on the calibrator.

Calibration principles

The calibrator can be calibrated:

- completely, i.e. all functions are calibrated in all recommended points
- partially, i.e. only selected functions are calibrated in all recommended points
- partially, i.e. only selected functions are calibrated in selected points

Complete calibration consists of all partial calibrations performed in the order defined by the calibration menu. If an item of the calibration menu, e.g. "VOLTAGE DC" is selected, it is not necessary to calibrate all ranges defined by the calibration algorithm. If new calibration of all ranges is not possible (e.g. the required standard is not available), old calibration data can be confirmed, i.e. current step of the calibration can be skipped.

Calibration interruption can be performed in any point of the calibration procedure. However this particular calibration influences parameters of the calibrator.

Accuracy of the calibrator is guaranteed when full calibration was done.

DC voltage calibration is performed by setting the zero and slope of the scale in all ranges and in both signal polarities (+ and -) (except the 1000 V range, where zero correction is not necessary).

AC voltage calibration is performed by setting the zero and slope of the scale in all ranges at 1000 Hz (except the 1000 V range, where the calibration is performed at 500 Hz).

DC current calibration is performed by setting the zero and slope of the scale in all ranges and in both signal polarities (+ and -).

AC current calibration is performed by setting the zero and slope of the scale in all ranges at 1000 Hz (except the 30 A, where the calibration is performed at 120 Hz).

Access to the calibration procedure

Calibration code is required to access the calibration procedure.

- Press SETUP to open the setup menu.
- Press CALIB display button.
- If an attempt is made to access the calibration procedure within 60 minutes after the calibrator was switched on, the calibrator does not open the respective menu and displays the following message instead:

Err 21
Time warm up !
xx minutes remain

- If the calibrator is already on for at least 60 minutes, it requests the entry of the calibration code after CAL. MODE display button is pressed.

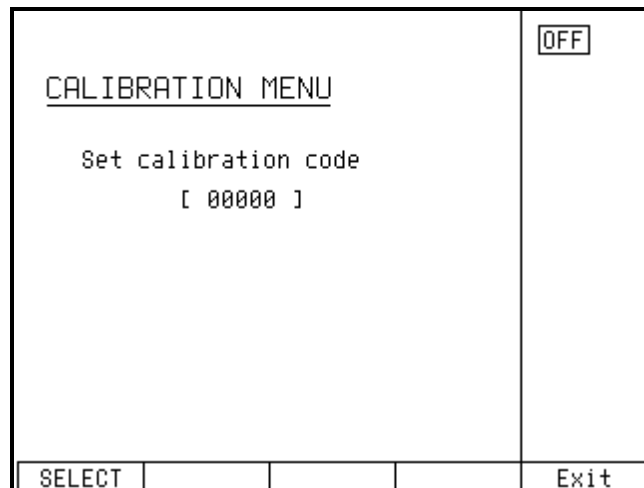

- Enter the correct calibration code using numeric keyboard and press ENTER.
- If incorrect calibration code is entered, an error message appears on the display for approximately 3 seconds:

Err 20
Bad calib. code!

- If correct calibration code is entered, calibration menu appears:

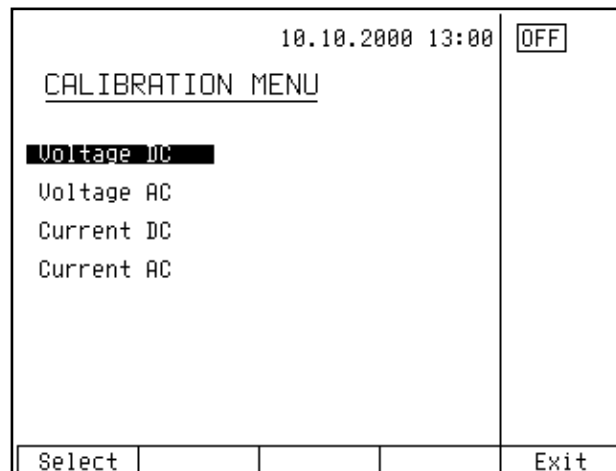

- Use \wedge and \vee cursor buttons to move the cursor through the list:
 1. VOLTAGE DC All DC voltage ranges calibration
 2. VOLTAGE AC All AC voltage ranges calibration
 3. CURRENT DC All DC current ranges calibration
 4. CURRENT AC All AC current ranges calibration

Note: All the rest functions labeled as N/A are not available in M-142i version.

Selection of calibration type

After the calibration menu is displayed, one of partial calibrations can be selected. Use \wedge and \vee cursor buttons to move the cursor through the list. Having selected the required function to be calibrated, press SELECT display button. The following data are shown (the following example is valid for VOLTAGE DC range):

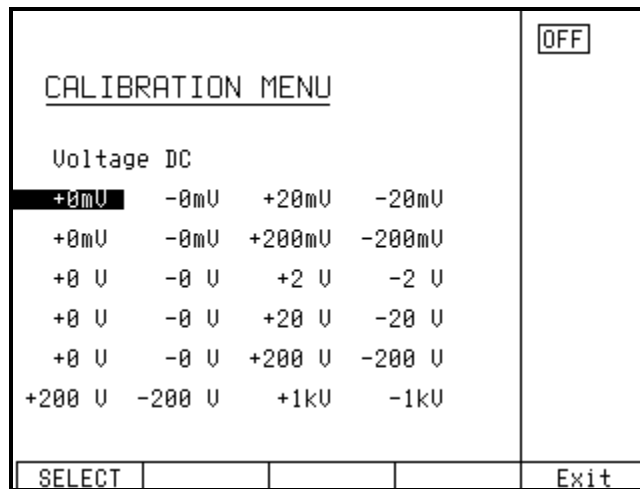

The table lists recommended calibration points. Having selected the required calibration point using SELECT display button, the following data are shown.

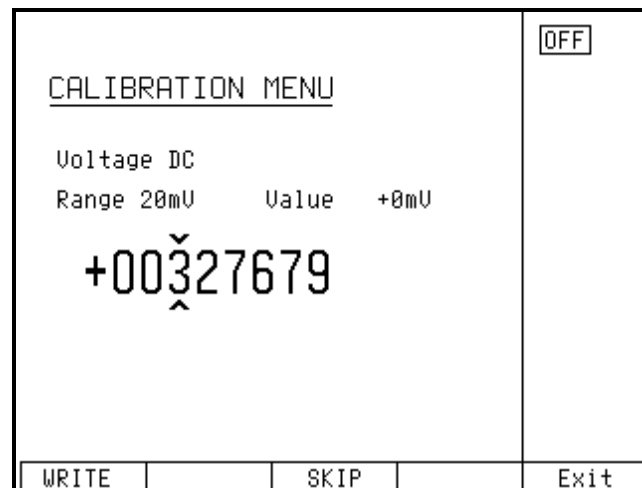

Display buttons have the following meaning:

- WRITE new calibration value is entered into the memory, old value is irreversibly lost
- SKIP current calibration step is skipped, old value is retained in the memory
- EXIT current calibration is terminated. After this button is pressed, the calibration memory hold all data (old or new entered) and the calibrator returns to the calibration menu. It is not necessary to calibrate all ranges; calibration of only selected ranges is possible by skipping the ranges which do not need to be calibrated.

Moreover, the display shows the range which is being calibrated (RANGE), and the value to be set at the external standard multimeter (VALUE).

Setting the new calibration data

Use \wedge , \vee , $<$, $>$ cursor buttons to set such main data on the display, when the output signal measured by external standard multimeter reaches the required calibration point. When the standard output value is reached, press "WRITE" to write new calibration value to the calibration memory. If you press "SKIP" button, the calibrator ignores the new value and old value is retained. After you press "WRITE" (or "SKIP"), the calibrator moves on to the next calibration point.

The procedure is repeated for all calibration points of the selected function. If you press "EXIT" button before completing the calibration, the calibrator returns to the calibration menu.

Termination of calibration

The calibration can be terminated in the following cases:

- complete calibration has been performed, new calibration data have been entered, the program has returned to the calibration menu,
- calibration of selected function has been performed, new calibration data have been entered, the program has returned to the calibration menu,
- calibration of selected range(s) of selected function has been performed, new calibration data have been entered, the program has returned to the calibration menu,
- the calibration has been started but no calibration data have been entered, the program has returned to the calibration menu after "EXIT" display button has been pressed,

Press "EXIT" display button to terminate the calibration. After the button is pressed, the calibration date is saved internally and the calibrator returns to the state it was in before the calibration has been started.

Calibration points

Each function of the calibrator has assigned fixed calibration points which have to be set during the calibration. For VOLTAGE DC, VOLTAGE AC, CURRENT DC, CURRENT AC the signal value is set using the keyboard. T function does not require any calibration, as the output voltage or resistance is based on arithmetic interpolation using standard tables of temperature sensor values.

The calibrator needs no calibration of the frequency parameter.

VOLTAGE DC function

<i>nominal value [V]</i>	<i>set limits [V]</i>	<i>range [V]</i>	<i>note</i>
0.0	2 u	20 m	zero calibration
0.0	2 u	-20 m	zero calibration
19 m	4 u	20 m	slope calibration
-19 m	4 u	-20 m	slope calibration
0.0	2 u	200 m	zero calibration
0.0	2 u	-200m	zero calibration
190 m	6 u	200 m	slope calibration
-190 m	6 u	-200m	slope calibration
0.0	5 u	2	zero calibration
0.0	5 u	-2	zero calibration
1.9	12 u	2	slope calibration
-1.9	12 u	-2	slope calibration
0.0	20 u	20	zero calibration
0.0	20 u	-20	zero calibration
19	100 u	20	slope calibration
-19	100 u	-20	slope calibration
0.0	200 u	200	zero calibration
0.0	200 u	-200	zero calibration
190	600 u	200	slope calibration
-190	600 u	-200	slope calibration
1000	20 m	1000	slope calibration
-1000	20 m	-1000	slope calibration

Tab.6 DC VOLTAGE

VOLTAGE AC function

<i>nominal value [V]</i>	<i>set limits [V]</i>	<i>range [V]</i>	<i>recommended frequency[Hz]</i>
1.9 m	5 u	20 m	1000
19 m	10 u	20 m	1000
19 m	15 u	200 m	1000
190 m	40 u	200 m	1000
190 m	30 u	2	1000
1.9	100 u	2	1000
1.9	200 u	20	1000
19	1 m	20	1000
19	5 m	200	1000
190	10 m	200	1000
190	50 m	1000	1000
750	50 m	1000	500

Tab.7 AC VOLTAGE

Other than recommended frequencies can be used for calibration. Specification of the calibrator is valid when recommended frequency is used.

CURRENT DC function

<i>nominal value [A]</i>	<i>set limits [A]</i>	<i>range [A]</i>	<i>note</i>
0.0	3 n	200 u	zero calibration
0.0	3 n	-200 u	zero calibration
190 u	5 n	200 u	slope calibration
190 u	5 n	-200 u	slope calibration
0.0	20 n	2 m	zero calibration
0.0	20 n	-2 m	zero calibration
1.9 m	50 n	2 m	slope calibration
1.9 m	50 n	-2 m	slope calibration
0.0	100 n	20 m	zero calibration
0.0	100 n	-20 m	zero calibration
19 m	200 n	20 m	slope calibration
-19m	200 n	-20 m	slope calibration
0.0	1 u	200 m	zero calibration
0.0	1 u	-200 m	zero calibration
190 m	2 u	200 m	slope calibration
-190 m	2 u	-200 m	slope calibration
0.0	20 u	2	zero calibration
0.0	20 u	-2	zero calibration
1.9	50 u	2	slope calibration
-1.9	50 u	-2	slope calibration
0.0	300 u	20	zero calibration
0.0	300 u	-20	zero calibration
19	600 u	20	slope calibration
-19	600 u	-20	slope calibration

Tab.8 DC CURRENT

CURRENT AC function

<i>nominal value [A]</i>	<i>set limits [A]</i>	<i>range [A]</i>	<i>recommended frequency[Hz]</i>
19 u	5 n	200 u	1000
190 u	50 n	200 u	1000
190u	40 n	2 m	1000
1.9 m	200 n	2 m	1000
1.9 m	200 n	20 m	1000
19 m	2 u	20 m	1000
19 m	2 u	200 m	1000
190 m	20 u	200 m	1000
190 m	20 u	2	500
1.9	200 u	2	500
1.9	1 m	20	120
10	3 m	20	120

Tab.9 AC CURRENT

Other than recommended frequency can be used for calibration. Specification of the calibrator is valid when recommended frequency is used.

Full calibration procedure

Following pages describe procedure of the full calibration.

Required instruments:

Following instruments are required for calibration:

- 8 1/2 digit multimeter type Agilent 3458A or Fluke 8508A or other type with accuracy 0.001 % on DC voltage
- Resistance shunt 10 mΩ, 100 mΩ Burster 1280, or other type with accuracy 0.01%
- Counter HP 53181A, HO 53130, BM 642 or other with accuracy 0,001 %

HP8903A Distortion analyzer and scope with bandwidth min. 20 MHz are recommended for THD measuring of AC signals.

Calibration procedure

1. Connect the calibrator and the multimeter to the mains and let them switched on for at least three hours in a laboratory at 23 ± 1 °C.
2. Press SETUP display button to call up the setup menu and then CALIB display button to call up the calibration menu.
3. Enter the calibration code and press ENTER (default calibration code is "00000").
4. **DC voltage ranges calibration**
 - a) Connect the voltage input terminals of the multimeter to the Hi - Lo output terminals of the calibrator.
 - b) Select VOLTAGE DC from the calibration menu and confirm by pressing SELECT button. Switch M-142i output terminals ON.
 - c) Follow the instructions provided on the calibrator's display and the DCU table to adjust the calibrator's output in the calibration points.
 - d) To adjust the calibrator's output in the calibration points, press SELECT button and use <, >, √, ^ cursor buttons or potentiometer to adjust output voltage. Confirm correctly set value by pressing WRITE display button. If you want to skip the calibration point whose calibration you have already entered, press SKIP display button.
 - e) Switch output terminals OFF
5. **AC voltage ranges calibration**
 - a) Select VOLTAGE AC from the calibration menu and confirm by pressing SELECT button. Switch M-142i output terminals ON.
 - b) Follow the instructions provided on the calibrator's display and the ACU table to adjust the calibrator's output in the calibration points.
 - c) To adjust the calibrator's output in the calibration points, press SELECT button and use <, >, √, ^ cursor buttons or potentiometer to adjust the output voltage. Confirm correctly set value by pressing WRITE display button. If you want to skip the calibration point whose calibration you have already entered, press SKIP display button.

- d) Switch output terminals OFF. Disconnect multimeter and calibrator.
6. **DC current ranges calibration**
- a) Connect current input terminals of the multimeter to the +I - -I output terminals of the calibrator. Select CURRENT DC from the calibration menu.
- b) Select DC current measurement range on external multimeter. Switch output terminals ON
- c) Follow the instructions provided on the calibrator's display and the DCI table to adjust the calibrator's output in the calibration points.
- d) To adjust the calibrator's output in the calibration points, press SELECT button and use <, >, √, ^ cursor buttons or potentiometer to adjust the output current. Confirm correctly set value by pressing WRITE display button. If you want to skip the calibration point whose calibration you have already entered, press SKIP display button.
- e) Resistance shunt should be used on 2A, 20 A ranges, if standard multimeter does not cover this range.
7. **AC current ranges calibration**
- a) Select CURRENT AC from the calibration menu. Set the same function on external multimeter.
- b) Follow the instructions provided on the calibrator's display and the ACI table to adjust the calibrator's output in the calibration points.
- c) To adjust the calibrator's output in the calibration points, press SELECT button and use <, >, √, ^ cursor buttons or potentiometer to adjust the output current. Confirm correctly set value by pressing WRITE display button. If you want to skip the calibration point whose calibration you have already entered, press SKIP display button.
- d) Resistance shunt should be used on 2A, 20 A ranges, if standard multimeter does not cover this range.

Error messages

If an error occurs during the calibrator's operation or control, error message is displayed on the display. Errors can be caused by:

- incorrect control using the front panel, i.e. attempts to force a prohibited mode, e.g. setting an out-of-range value, overloading of output terminals etc.,
- fault of the calibrator, e.g. internal communication error during the communication between individual functional blocks,
- incorrect control using RS-232 interface.

Below you can see a sample error message which appears when too large value is attempted to set up. All error messages are displayed in the center of the display.

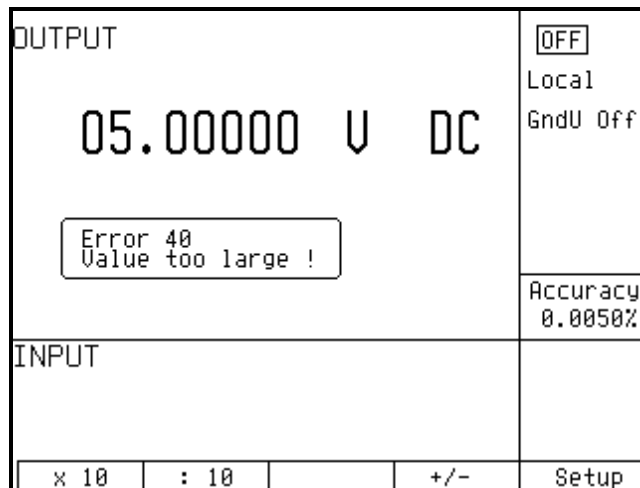

The following table lists all error messages, their meaning and simple troubleshooting.

No error	Label	description	troubleshooting
01	Overload 2V !	2V range overloaded	Output current is too high. Increase load resistance.
02	Overload 20V !	20 V range overloaded	Output current is too high. Increase load resistance.
03	Overload 200V !	200, 1000 V ranges overloaded	Output current is too high. Increase load resistance.
04	Overload I output !	Current output overloaded	Voltage on the load is too high. Decrease load resistance.
05	High temperature !	Too high internal temperature	Output stages are overloaded. Do not use ranges 200V, 1000V or 20 A for at least 10 minutes. Check if the ventilation holes are free.
06	Overload RC !	RC simulator overloaded	Test current is too high. Use lower range of tested Ohmmeter.
07	FBK error !	Internal error	Turn off the calibrator and turn on it again.
08	OUTPUT must be in OFF state !	Cable adapter tried to be exchanged while output terminals was ON	Switch off output terminals with button OUTPUT, change the adapter, and switch output terminals on.
20	Bad calib. code !	Bad calibration code	Wrong calibration code was entered, calibration cannot start. Enter correct calibration code.
21	Time warm up !	Attempt to start calibration before warm up	Attempt to start calibration before 60 minutes warm up period. Let the calibrator turned on for at least 60 minutes.
30	Internal RxD timeout !	Internal error	Internal error of the calibrator. Turn the calibrator off and after 5 s turn on. If the error will appear again, contact manufacturer.
31	Internal communication !	Internal error	Internal error of the calibrator. Turn the calibrator off and after 5 s turn on. If the error will appear again, contact manufacturer.
37	Calibrator is not ready !	Internal error	Internal error of the calibrator. Turn the calibrator off and after 5 s turn on. If the error will appear again, contact manufacturer.
40	Value too large !	Maximum value is out of limit	Attempt to set value over possible range. Set correct value.
41	Value too small !	Minimum value is out of limit	Attempt to set value under possible range. Set correct value.
42	Deviation too large !	Deviation is too high	Set deviation is out of limit -30% to +30%. Set correct value.
44	Unable +/- !	Change of polarity is not allowed	Attempt to change polarity, where it is not allowed.. Concerned modes ACV, ACI.
45	Unable - polarity !	Negative polarity is not allowed.	Attempt to set negative polarity, where it is not allowed.. Concerned modes ACV, ACI.
46	Unable DC/AC !	DC/AC conversion is not possible	Attempt to change parameter AC/DC where it is nonsense or where it is not allowed.
47	Current timeout !	Time limit for current over 10 A exceeded	Long-term loading current terminals with output current over A.

Functional description of the calibrator

Basic blocks

Basic functional blocks are:

- front panel keyboard
- LCD display
- output terminals
- output voltage amplifier 200 V
- output voltage amplifier 20 A
- main board
- voltage amplifier 2 V
- voltage amplifier 20 V
- DC reference voltage with DAC
- generator
- feedback circuits
- phase shift circuits
- current ranges generator
- multimeter
- power line transformer
- power supply board
- interface GPIB and RS232

Note: List of basic functional blocks contains all blocks of M-142i model. In M-142i version some of them miss.

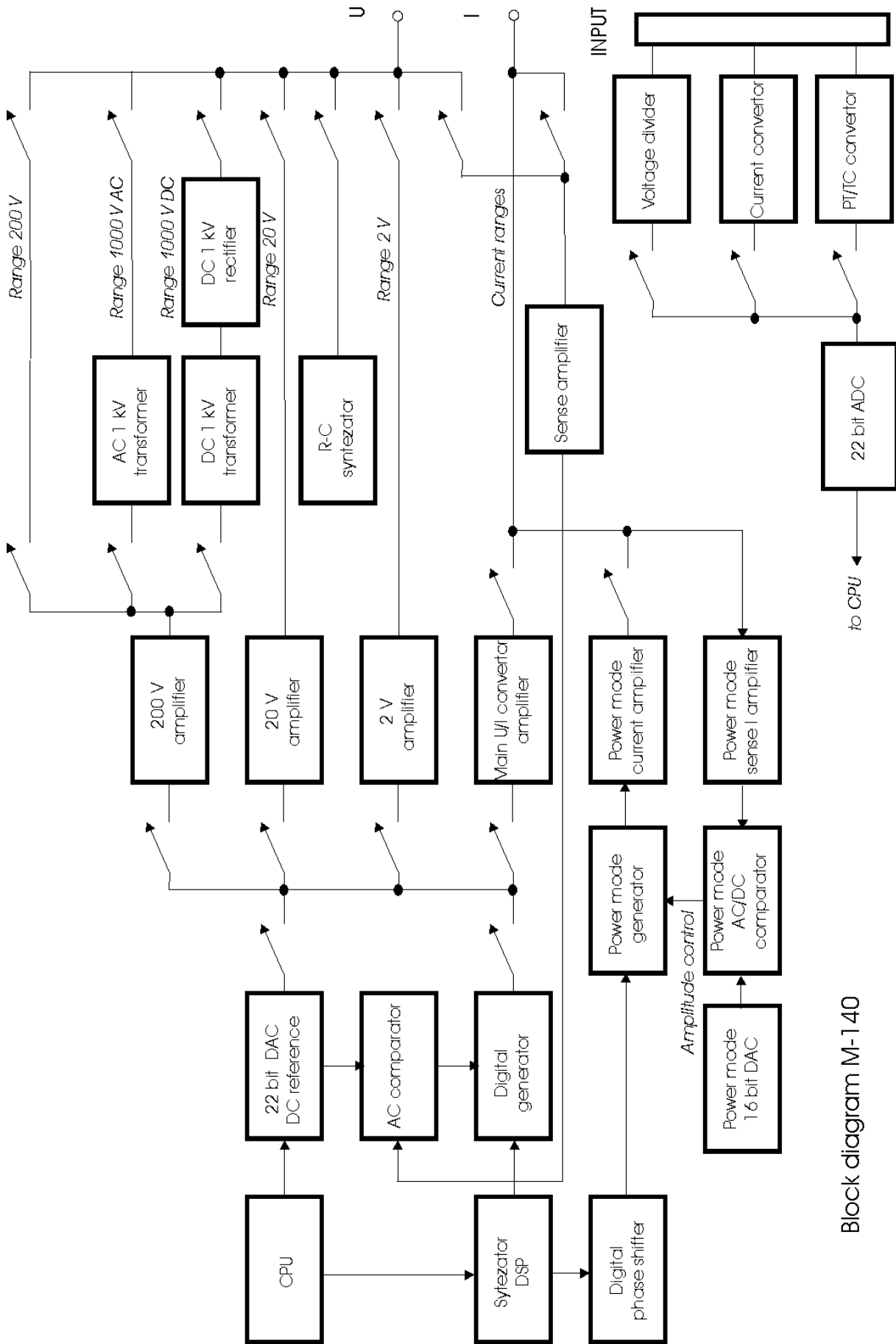

Block diagram M-140

2, 20 V DC voltage ranges

The functional scheme is shown in the picture below:

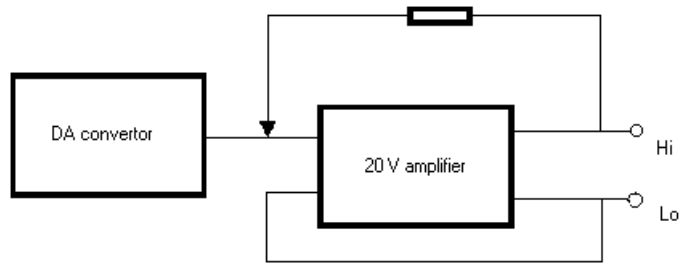

There is a DC reference voltage source integrated within the 22bit measurement converter. Its output is fed to the output stage for 2 and 20 V range. Output voltage present at Hi and Lo terminals is sensed by sensing wires. Feedback eliminates the influence of amplifier's output impedance and of the resistance of wires within the calibrator.

200 V DC voltage range

The block diagram functional scheme is shown in the picture below.

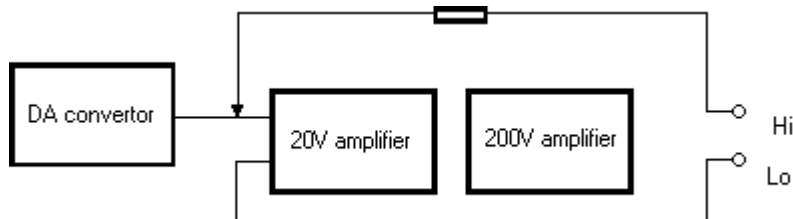

The scheme is similar to 2 and 20 V ranges. A 240 V power amplifier with electronic fuses is connected to the output of 20 V amplifier.

2 to 200 V AC voltage ranges

The functional scheme is shown in the picture below:

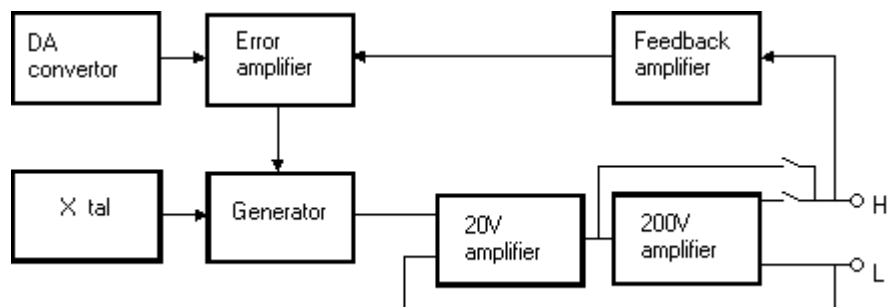

The calibrator's built-in generator generates a sine wave with voltage-controlled amplitude. The frequency is derived from microprocessor control circuit's crystal oscillator. The signal is fed to 20 V or 200 V amplifier and then to output terminals. Feedback circuits sense the voltage present at the output terminals, normalize its value and detects it. This results in a signal corresponding to average value of the output voltage. This signal is further filtered and compared to the set value of output voltage. The error value controls the amplitude of the generator's output.

20mV and 200 mV voltage ranges

20 mV and 200 mV voltage ranges are derived from 2 and 20 V voltage ranges.

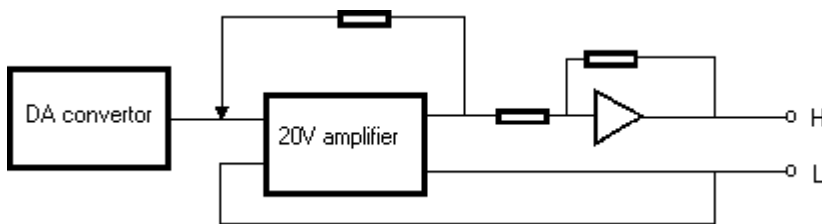

The output of the amplifier is fed to an inverting attenuator with 1:100 nominal division ratio. The signal is then led to the output terminals, sensed via local feedback. This connection allows to load the calibrator output with output current of several mA without losing accuracy.

1000 V AC, DC voltage range

The highest voltage range of the calibrator uses 200 V amplifier. It is connected to a pair of transformers with ca 1:6 transformation ratio.

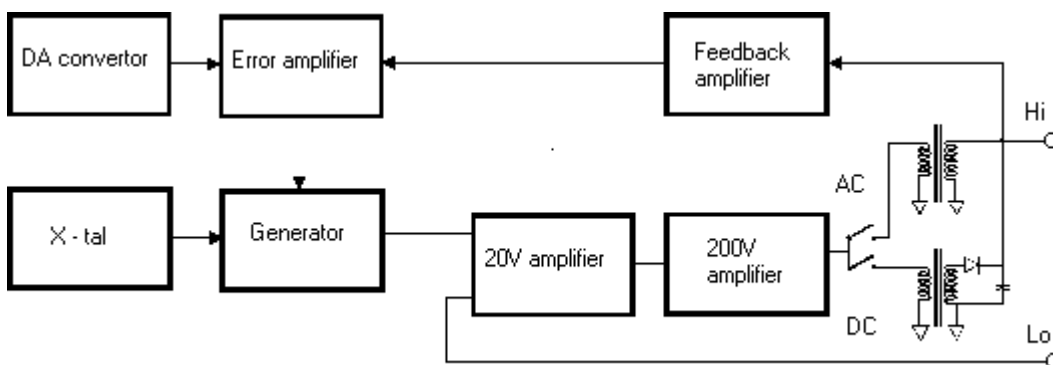

In 1000 V AC mode, the output of 200 V amplifier is transformed and led to the output terminals. The output voltage is sensed, rectified and compared to reference DC voltage provided by the DA converter. error value controls the amplitude of the generator's output so that there is correct voltage at the output terminals.

In 1000 V DC mode, 12 kHz signal is transformed, rectified, filtered and led to the output terminals. The output voltage is sensed equally to 1000 V AC mode.

Current converter

The current converter and current amplifier form a separate design block based on a transconductivity converter with 10^{-5} S nominal conversion ratio.

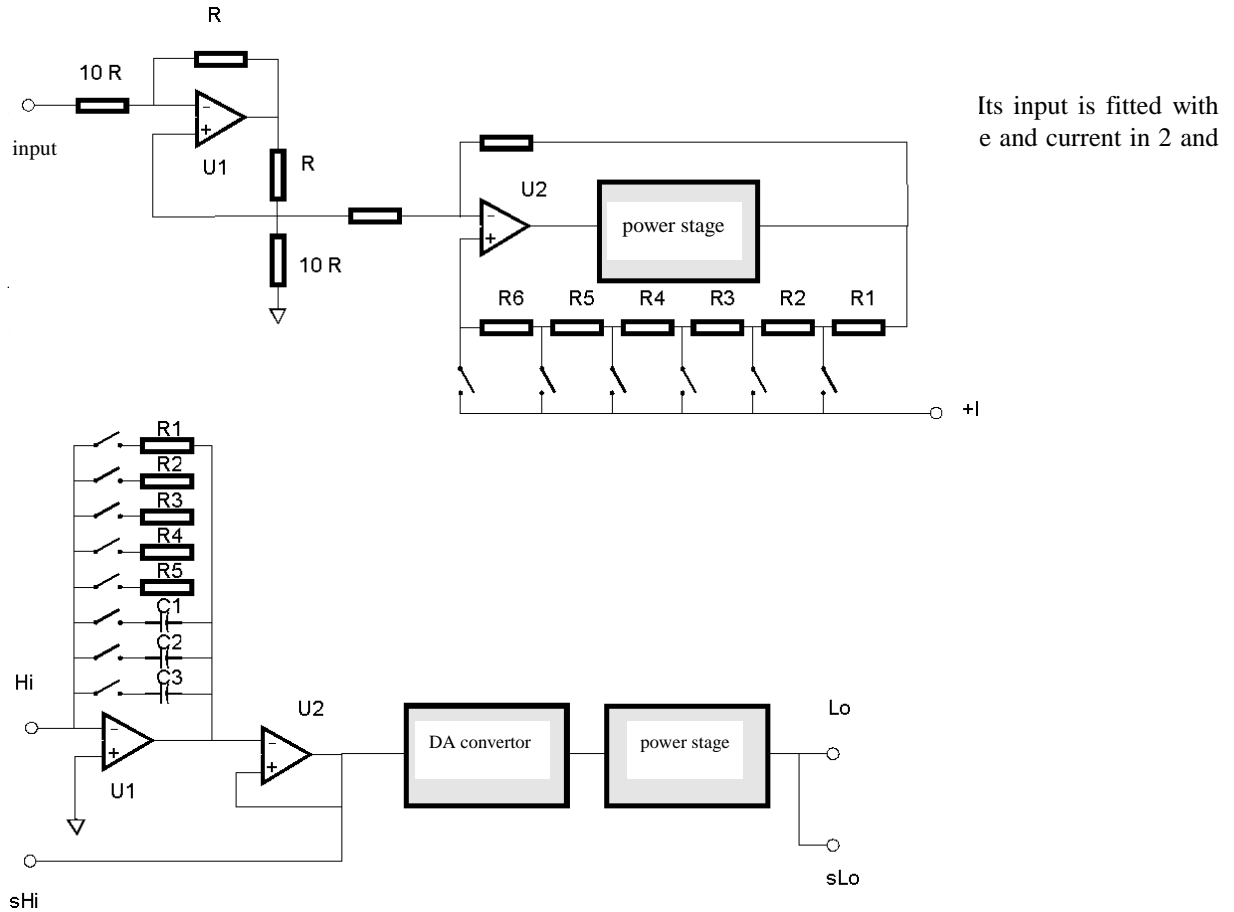

Hi and Lo are calibrator’s output terminals. The stage including U1 operating amplifier converts voltage to current. U2 is a separation amplifier. R1 to R5 and C1 to C3 are range impedance. DA converter has 0 to +1 and 0 to -1 conversion ration and allows the simulation of resistance and capacitance values different from the range impedances. The output stage increases the permitted current load of the output.



ATTENTION

The simulator’s output voltage (Hi - Lo terminals) is limited to 8 Vpk.

Frequency synthesizer

Frequency synthesis circuitry allows fine setting of frequency in the whole calibrator’s range. Frequency synthesis uses DSP circuits with basic frequency 20 MHz.

Calibrator's maintenance

The multifunction calibrator is electronic instrument with microprocessor control. All blocks which are heavily loaded during the operation are cooled by a fan.

Rules for correct operation

Especially the following rules should be adhered to guarantee correct operation of the calibrator:

- *The calibrator can only be switched on and off by pressing the mains switch located at the rear panel.*
- *Do not connect the calibrator to other voltage than set by the voltage selector.*
- *Do not block the vent openings located at the rear panel and bottom panel.*
- *The calibrator must not be operated in dusty environment. It was designed to be used in a laboratory.*
- *No liquid or small objects can be permitted to enter the calibrator through the vent openings..*
- *Do not switch the calibrator outside its operating temperature range.*
- *Connect the instruments to be calibrated to proper output terminals. There is no way of protecting the calibrator from the damage caused by some improper connections.*
- *Do not damage the output terminals by plugging in "bananas" thicker than the terminals were designed for.*
- *Whenever possible, use the setup menu to ground Lo output terminal (GND U ON setup function).*
- *Do not overload the power stages by leaving the calibrator switched on with the load connected for a long time, especially on 20 A current range and 200V and 1000 V voltage ranges.*
- *If the instruments to be calibrated are not connected to calibrator's output terminals using original cables, ensure that cables suitable for the calibration voltage and current are used. Maximum output voltage can reach 1000 V AC and the maximum output current can reach 20 A AC.*

Regular maintenance

The calibrator does not require any special maintenance of electrical or mechanical parts. If it gets dirty, the case and the display can be cleaned by a wool rag moistened with alcohol.

The calibrator should be calibrated in the recommended 12-month intervals. A calibration center should perform the calibration.

What to do in case of failure

If an **obvious failure** occurs during the operation (e.g. the display is not lit, the fan is not turning), the calibrator must be switched off immediately. First, check the fuse located in the power cord receptacle. Procedure is following:

- Remove the end of power cord from the mains connector at the rear panel.

- Insert the blade of a flat screwdriver into the opening cut in the mains voltage selector and pry out the fuse holder.
- Remove the fuse. Replace it with new fuse of the same rating if the fuse was broken.
- Replace the fuse holder, reconnect the power cord and switch on the calibrator. If the problem persists, contact the manufacturer.

If an obvious fault is evidenced, e.g. a measurement range or an operating mode is not functional, the user cannot correct the fault. Contact the manufacturer.

Hidden faults can cause different symptoms and be caused by different causes. Usually, they cause instability of some parameter. Hidden defects can be caused by unacceptable distortion, degraded insulation etc. In this case contact the manufacturer.

Sometimes it seems that the calibrator has hidden defect, when the rules for correct operation are not adhered to. In this case, the fault is caused by the operator. Most frequent cases of false “hidden defects”:

- mains voltage out of tolerance limits or unstable
- wrong grounding of the measurement circuit (bad connection of the ground terminal of the mains outlet, or several ground connection when grounding loops are formed)
- proximity to sources of intensive influence, whose products are spread through the mains or propagated by the electromagnetic field
- strong electrostatic or electromagnetic field which can cause major instability during calibration using higher impedance.

Verification test

Procedure recommended for verifying parameters of the calibrator is described in this chapter. During tests it is not necessary access to the interior of the instrument.

Required equipment

Following instruments are required for performance verification test:

- 8 1/2 digit multimeter type Agilent 3458A or Fluke 8508A or other type with accuracy 0.001 % on DC voltage
- resistance shunt 10 m Ω , 100 m Ω Burster 1280, or other type with accuracy 0.01%
- counter HP 53181A, HO 53130, BM 642 or other with accuracy 0,001 %

HP8903A Distortion analyzer and scope with bandwidth min. 20 MHz are recommended for THD measuring of AC signals.

Configuration of the calibrator

Calibrator should be tested directly from the front panel terminals and without use of terminal adapter 140-01 or 140-41. For build-in multimeter testing cable adapters Option 40 and Option 60 are recommended. To suppress influence of noise or interference with power line frequency in measuring circuit it is recommended following setting of the calibrator (in SETUP MENU):

- **Coil x50** **OFF**
- **GND U** **ON (in capacitance test OFF)**
- **GND I** **ON (in capacitance test OFF)**

Note: It is recommended to ground only the voltage channel GND U ON, GND I OFF, for all ranges except the generation of power or energy. If the meter to be calibrated has Lo terminal grounded, it is recommended to un-ground both outputs of the calibrator, GND U OFF, GND I OFF to exclude ground loops.

If it is grounded neither calibrator nor standard meter, higher level can occur on the output terminals.

In general, when calibrator is connected to the standard meter, ground loops can be arise through power line connection. Ground loops can result apparently worse noise, short term stability or non-harmonic distortion of output signal. If necessary use toroidal chokes to suppress this products.

In all other items in SETUP MENU the setting of parameters don't influence accuracy of the calibrator.

Use sin waveform of the output signal on all AC tests.

Performance verification may be performed after warm-up period i.e. 1 hour after switching on. Calibrator have to be in temperature stabilize condition at minimum 8 hours before performance verification test is started.

Basic steps of the performance verification test

Verification procedure consists of following steps:

- **20 V DC voltage** test with linearity check

- **DC voltage** internal ranges 20 mV, 200 mV, 2 V, 240 V, 1000 V test
- **20 V AC voltage** test with linearity check
- **AC voltage** internal ranges 20 mV, 200 mV, 2 V, 20V, 240 V, 1000 V test
- **200 mA DC current** test with linearity check
- **DC current** internal ranges 200 uA, 2 mA, 20 mA test
- **AC current** internal ranges 200 uA, 2 mA, 20 mA, 200 mA test
- **AC/DC high current** ranges 2 A, 20 A test
- **Frequency** nominal value 1 kHz test
- **Distortion** checking of AC voltage, range 20 V.

Procedure

Following part describes procedure of performance verification test. Recommended measuring points are the same as the points in table of limits (see tables below).

1. Connect the calibrator to the mains and let them switched on for at least one hour in a laboratory at 23 ± 1 °C.
2. Connect voltage input of the standard multimeter to the voltage output terminals of the calibrator. Set appropriate parameters on the standard multimeter to achieve its best accuracy.
3. Perform 20 VDC linearity, DC voltage, 20 VAC linearity, AC voltage tests according to the tables I, II, III, IV. Deviations should not exceed specified limits.
4. Connect current input of standard multimeter to the current output terminals of the calibrator. Set appropriate parameters on the standard multimeter to meet its best accuracy.
5. Perform 200 mADC linearity, DC current, AC current tests according to the tables V, VI, VII. Deviations should not exceed specified limits.
6. Connect current output terminals of the calibrator to the current terminals of resistance shunt 100 mOhm. Connect voltage input of standard multimeter to the voltage terminals of the resistance shunt. Set range 100 (200)mV on standard multimeter.
7. Perform AC/DC high current test on range 2 A according to the table VIII. Deviation should not exceed specified limit.
8. Connect current output terminals of the calibrator to the current terminals of resistance shunt 10 mOhm. Connect voltage input of standard multimeter to the voltage terminals of the resistance shunt. Set range 100 (200)mV on standard multimeter.
9. Perform AC/DC high current test on range 30 A according to the table VIII. Deviation should not exceed specified limit.
10. Perform frequency test according to the table IX. Deviation should not exceed specified limit.
11. Check harmonic distortion of output signal. It should not exceed 0.05%.

If calibrator is out of limits is in some points of this test, appropriate function and range should be recalibrated. It is not necessary to recalibrate all functions, but only this one, which does not meet specification. See chapter Calibration mode, where recalibration procedure is described.

Tables of limits**20 V DC Basic range with linearity test**

Function	Range	Value (V)	Frequency (Hz)	Deviation allowed(μ V)
V-DC	20.0 V	2.0	DC	70
V-DC	20.0 V	4.0	DC	90
V-DC	20.0 V	6.0	DC	110
V-DC	20.0 V	8.0	DC	130
V-DC	20.0 V	10.0	DC	150
V-DC	20.0 V	12.0	DC	170
V-DC	20.0 V	14.0	DC	190
V-DC	20.0 V	16.0	DC	210
V-DC	20.0 V	18.0	DC	230
V-DC	20.0 V	19.0	DC	240
V-DC	20.0 V	-2.0	DC	70
V-DC	20.0 V	-4.0	DC	90
V-DC	20.0 V	-6.0	DC	110
V-DC	20.0 V	-8.0	DC	130
V-DC	20.0 V	-10.0	DC	150
V-DC	20.0 V	-12.0	DC	170
V-DC	20.0 V	-14.0	DC	190
V-DC	20.0 V	-16.0	DC	210
V-DC	20.0 V	-18.0	DC	230
V-DC	20.0 V	-19.0	DC	240

Table I

DC voltage test

Function	Range	Value (V)	Frequency (Hz)	Deviation allowed(V)
V-DC	2.0 V	1.9	DC	33 μ
V-DC	2.0 V	-1.9	DC	33 μ
V-DC	240.0 V	190.0	DC	3.335 m
V-DC	240.0 V	240.0	DC	4.100 m
V-DC	240.0 V	-190.0	DC	3.335 m
V-DC	240.0 V	-240.0	DC	4.100 m
V-DC	1000.0 V	1000.0	DC	55 m
V-DC	1000.0 V	-1000.0	DC	55 m

Table II

20 V AC Basic range with linearity test

Function	Range	Value (V)	Frequency (Hz)	Deviation allowed(%value)
V-AC	20.0 V	2.0	1000	1.36 m
V-AC	20.0 V	4.0	1000	1.72 m
V-AC	20.0 V	6.0	1000	2.08 m
V-AC	20.0 V	8.0	1000	2.44 m
V-AC	20.0 V	10.0	1000	2.80 m
V-AC	20.0 V	12.0	1000	3.16 m
V-AC	20.0 V	14.0	1000	3.52 m
V-AC	20.0 V	16.0	1000	3.88 m
V-AC	20.0 V	18.0	1000	4.24 m
V-AC	20.0 V	19.0	1000	4.42 m

Table III

AC voltage test

Function	Range	Value (V)	Frequency (Hz)	Deviation allowed(V)
V-AC	20 mV	0.019	1000	68 μ
V-AC	200 mV	0.19	1000	270 μ
V-AC	2.0 V	1.9	1000	442 μ
V-AC	20.0 V	19.0	50	4.42 m
V-AC	20.0 V	19.0	120	4.42 m
V-AC	20.0 V	19.0	10000	4.42 m
V-AC	20.0 V	19.0	20000	15.5 m
V-AC	20.0 V	19.0	50000	15.5 m
V-AC	240.0 V	190.0	1000	44.2 m
V-AC	1000 V	750.0	120	500.0 m

Table IV

200 mA DC Basic range with linearity test

Function	Range	Value (A)	Frequency (Hz)	Deviation allowed(μ A)
A-DC	200.0 mA	0.02	DC	8
A-DC	200.0 mA	0.04	DC	10
A-DC	200.0 mA	0.06	DC	12
A-DC	200.0 mA	0.08	DC	14
A-DC	200.0 mA	0.10	DC	16
A-DC	200.0 mA	0.12	DC	18
A-DC	200.0 mA	0.14	DC	20
A-DC	200.0 mA	0.16	DC	22
A-DC	200.0 mA	0.18	DC	24
A-DC	200.0 mA	0.19	DC	25
A-DC	200.0 mA	-0.02	DC	8
A-DC	200.0 mA	-0.04	DC	10
A-DC	200.0 mA	-0.06	DC	12
A-DC	200.0 mA	-0.08	DC	14
A-DC	200.0 mA	-0.10	DC	16
A-DC	200.0 mA	-0.12	DC	18
A-DC	200.0 mA	-0.14	DC	20
A-DC	200.0 mA	-0.16	DC	22
A-DC	200.0 mA	-0.18	DC	24
A-DC	200.0 mA	-0.19	DC	25

Table V

DC current test

Function	Range	Value (A)	Frequency (Hz)	Deviation allowed(A)
A-DC	200.0 μ A	0.00019	DC	0.115 μ
A-DC	200.0 μ A	-0.00019	DC	0.115 μ
A-DC	2.0 mA	0.0019	DC	0.430 μ
A-DC	2.0 mA	-0.0019	DC	0.430 μ
A-DC	20.0 mA	0.019	DC	2.5 μ
A-DC	20.0 mA	-0.019	DC	2.5 μ

Table VI

AC current test

Function	Range	Value (A)	Frequency (Hz)	Deviation allowed(A)
A-AC	200.0 μ A	0.00019	60	0.305 μ
A-AC	2.0 mA	0.0019	60	1.53 μ
A-AC	20.0 mA	0.019	60	10.5 μ
A-AC	20.0 mA	0.019	120	10.5 μ
A-AC	20.0 mA	0.019	1000	10.5 μ
A-AC	20.0 mA	0.019	10000	109 μ
A-AC	200.0 mA	0.19	60	105 μ

Table VII

AC/DC high current test

Function	Range	Value (A)	Frequency (Hz)	Deviation allowed(%value)
A-DC	2.0 A	1.0	DC	250 μ
A-DC	2.0 A	-1.0	DC	250 μ
A-AC	2.0 A	1.0	60	600 μ
A-DC	30.0 A	10.0	DC	4 m
A-DC	30.0 A	-10.0	DC	4 m
A-AC	30.0 A	10.0	60	16 m
A-DC	30.0 A	30.0	DC	17 m
A-DC	30.0 A	-30.0	DC	17 m
A-AC	30.0 A	30.0	60	45 m

Table VIII

Frequency test

Function	Range	Value (Hz)	Frequency (Hz)	Deviation allowed(%value)
FREQ	1 kHz	1000.0		0.005

Table IX

System control

The calibrator includes RS232 serial line. System connectors are located at the rear panel. For the remote control to work properly, bus parameters must be set in the system menu. For RS232 bus, communication speed can be set (150 to 19200 Bd) and software handshake XON/XOFF can be set.

RS232 bus properties

To transfer the data using RS232 bus, 8N1 data format is used, i.e. each data word includes 8 bits, no parity and one stop bit. The communication speed can be set using the system menu. Available values: 150, 300, 600, 1200, 2400, 4800, 9600 and 19200 Bd. Software handshake (communication control) XON/XOFF can be set to control the transfer of the data through the bus.

RS-232 connector layout

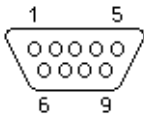

Pin	Label	Direction	Note
2	TXD	output	transmitter
3	RXD	input	receiver
5	GND	-	ground

9-pin connector D-SUB FEMALE

Cable between the calibrator and PC (configuration 1:1)

PC	D-Sub 1	D-Sub 2	M-142i
Receiver	2	2	Transmitter
Transmitter	3	3	Receiver
Ground	5	5	Ground

Command syntax

The commands described in this chapter can be issued through both buses (IEEE-488 and RS232).

All commands listed in this chapter are explained in two columns:

KEYWORD and PARAMETERS.

KEYWORD column includes the name of the command. Each command includes one or more keywords. If a keyword is in brackets ([]), it is not mandatory. Non-mandatory commands are used only to achieve compatibility with language standard SCPI.

Capitals designate the abbreviated form of the commands; extended form is written in lowercase.

Command parameters are in brackets (<>); each parameter is separated using a comma. Parameters in brackets ([]) are not mandatory. Line (|) means “or” and is used to separate several alternative parameters.

Semicolon ‘;’ is used to separate more commands written on one line.

E.g. VOLT 2.5 ; OUTP ON

Note:

Each command must end in <cr> or <lf>. Both codes <crlf> can be used at the same time. The calibrator performs all commands written on one line of the program after it receives <cr>, <lf> or <crlf> code. Without this code, the program line is ignored.

Description of abbreviations

- <DNPD> = Decimal Numeric Program Data, this format is used to express decimal number with or without the exponent.
- <CPD> = Character Program Data. Usually, it represents a group of alternative character parameters. E.g. {ON | OFF | 0 | 1}.
- ? = A flag indicating a request for the value of the parameter specified by the command. No other parameter than the question mark can be used.
- (?) = A flag indicating a request for the parameter specified by the command. This command permits a value to be set as well as requested.
- <cr> = carriage return. ASCII code 13. This code executes the program line.
- <lf> = line feed. ASCII code 10. This code executes the program line.

OUTPut subsystem

This subsystem allows to control the output terminals of M142i calibrator, to activate the four-wire output or to switch the calibrator to x50 current coil (option 140-50).

Keyword	Parameters
OUTPut	
[:STATe] (?)	<CPD> { ON OFF 0 1 }
:ISELection (?)	<CPD> { HIGHi HI50turn }

OUTP [:STAT] (?) <CPD> { ON | OFF | 0 | 1 }

This command activates or deactivates the output of M142i calibrator.

- ON or 1 - activates the output
- OFF or 0 - deactivates the output

If query is sent, M142i returns ON if the output is active or OFF if it is inactive

Example: OUTP 1 <cr> - activates the output
 OUTP ? <cr> - the calibrator returns ON or OFF

OUTP :ISEL (?) <CPD> { HIGH | HI50 }

This command activates or deactivates the 1000A current range (using a 50-turn coil).

- HIGH - deactivates the 50-turn coil
- HI50 - activates the 50-turn coil (up to 1000A range)

If query is sent, M142i returns HIGH if the 50-turn coil is deactivated or HI50 if it is activated.

Example: OUTP :ISEL HI50 <cr> activates the 50-turn coil
 OUTP :ISEL ? <cr> the calibrator returns HIGH or HI50

SOURce subsystem

This subsystem allows to control the individual functions of M142i calibrator.

Keyword	Parameters
---------	------------

```

[SOURce]
  : VOLTage
    [: LEVEl]
      [: IMMEDIATE]
        [: AMPLitude] (?)          <DNPd>

  : CURRent
    [: LEVEl]
      [: IMMEDIATE]
        [: AMPLitude] (?)          <DNPd>

  : EARTH
    : VOLTage (?)                  <CPD> { ON | OFF | 0 | 1 }
    : CURRent (?)                   <CPD> { ON | OFF | 0 | 1 }

  : TEMPerature
    : UNITs (?)                     <CPD> { C | CEL | K }
    : SCALe (?)                     <CPD> { TS68 | TS90 }
    : THERmocouple
      [: LEVEl]
        [: IMMEDIATE]
          [: AMPLitude] (?)          <DNPd>

    : RJUNction (?)                 <DNPd>
    : TYPE (?)                       <CPD> { B | E | J | K | N | R | S | T }

```

[SOUR] :VOLT [:LEVE] [:IMM] [:AMPL] (?) <DNPd>

This command activates the generation of DC or AC voltage (depending on the DC or SIN parameter of the FUNC command).

<DNPd>

Represents the value of DC or AC voltage expressed in Volts. Negative value is accepted for DC voltage. "Technical Data" chapter lists the acceptable ranges.

If query is sent, M142i returns the set value of current using standard exponential format. Example: 20.547mV is returned as -2.054700e-002. Positive numbers are not preceded with "+" sign.

[SOUR] :CURR [:LEVE] [:IMM] [:AMPL] (?) <DNPd>

This command activates the generation of DC or AC current (depending on the DC or SIN parameter of the FUNC command).

<DNPd>

Represents the value of DC or AC current expressed in Amperes. Negative value is accepted for DC current. "Technical Data" chapter lists the acceptable ranges.

If query is sent, M142i returns the set value of current using standard exponential format. Example: 20.547mA is returned as -2.054700e-002. Positive numbers are not preceded with "+" sign.

[SOUR] :EART :VOLT (?) <CPD> { ON | OFF | 0 | 1 }

This command connects or disconnects the voltage Lo terminal to/from GND terminal.

- ON or 1 grounds the voltage output
- OFF or 0 ungrounds the voltage output

If query is sent, M142i returns ON when the output is grounded or OFF when ungrounded.

Example: EART : VOLT 1 <cr> - grounds the voltage output terminals
 EART : VOLT ? <cr> - the calibrator returns ON or OFF

[SOUR] :EART :CURR (?) <CPD> { ON | OFF | 0 | 1 }

This command connects or disconnects the current Lo terminal to/from GND terminal.

- ON or 1 grounds the current output
- OFF or 0 ungrounds the current output

If query is sent, M142i returns ON if the current terminals are grounded or OFF if ungrounded.

Example: EART : CURR 1 <cr> - grounds the current output terminals
 EART : CURR ? <cr> - the calibrator returns ON or OFF

[SOUR] :FREQ [:CW] (?) <DNPD>

This command sets the frequency being generated.

Examples:

AC voltage frequency :

 FUNC :SIN ; :VOLT <DNPD>; :FREQ <DNPD> <cr>

AC current frequency :

 FUNC :SIN ; :CURR <DNPD>; :FREQ <DNPD> <cr>

Digital frequency :

 FUNC :SQU ; :FREQ <DNPD> <cr>

<DNPD>

Represents the frequency in Hz. . “Technical Data” chapter lists the acceptable ranges which depend on the selected function mode.

If query is sent, M142i returns the set value of the current using standard exponential format. Example: 20.5kHz is returned as 2.050000e+004.

[SOUR] :TEMP :UNIT (?) <CPD> { C | CEL | K }

This command sets the unit of measurement of temperature.

- C or CEL sets „Centigrade“
- K sets „Kelvin“

The unit of measurement remains valid after the calibrator is switched off.

If query is sent, M142i returns the set unit of measurement { C | K }.

[SOUR] :TEMP :SCAL (?) <CPD> { TS68 | TS90 }

This command sets one of temperature scales. The setting influences the simulation of resistance temperature sensors and thermocouples.

- TS68 sets IPTS-68 temperature scale
- TS90 sets ITS-90 temperature scale

The temperature scale remains valid after the calibrator is switched off.

If query is sent, M142i returns the set temperature scale { TS68 | TS90 }.

[SOUR] :TEMP :THER [:LEVE] [:IMM] [:AMPL] (?) <DNPD>

This command activates the simulation of thermocouples (DC voltage generation).

<DNPD>

Represents the temperature expressed in the units set by the 'UNIT' command. "Technical Data" chapter lists the acceptable ranges.

If query is sent, M142i returns the set temperature using standard exponential format. Example: 20.5°C is returned as 2.050000e+001.

[SOUR] :TEMP :THER :RJUN (?) <DNPD>

This command sets the temperature of cold end of thermocouple.

<DNPD>

Represents the temperature expressed in the units set by the 'UNIT' command. "Technical Data" chapter lists the acceptable ranges.

Example: to set the temperature of cold end of thermocouple to 25°C:

```
:TEMP :THER :RJUN 25 <cr>
```

If query is sent, M142i returns the set temperature using standard exponential format. Example: 20.5°C is returned as 2.050000e+001.

[SOUR] :TEMP :THER :TYPE (?) <CPD> { B | E | J | K | N | R | S | T }

This command sets the type of thermocouple to be simulated.

Example: to activate the simulation of S type thermocouple at 350°C:

```
:TEMP :THER 350; :TEMP :THER :TYPE S <cr>
```

If query is sent, M142i returns the set type thermocouple { B | E | J | K | N | R | S | T }.

I/D (instrument identification)

***IDN?**

This command returns the identification of the manufacturer, model, serial number and firmware revision.

The reply is formatted as follows:

```
MEATEST, M-142, 412341, 4.6
```

Operation complete

***OPC <cr>**

This command sets the OPC bit in the ESR (Event Status Register) when all pending operations are complete.

Operation complete?

***OPC? <cr>**

This command returns "1" to the output queue after all pending operations are complete.

Operation complete?

***OPC? <cr>**

This command returns “1” to the output queue after all pending operations are complete.

Wait-to-Continue command

***WAI** <cr>

Prevents the instrument from executing any further commands or queries until all previous remote commands have been executed.

Reset

***RST** <cr>

This command resets the calibrator to its initial status.

Test operation

***TST?** <cr>

This command executes an internal self-test. Return the self-test result (“0” for pass or “1” for fail).

Remote control

***REM** <cr>

This command activates the remote control. When remote control is active, the calibrator ignores all controls from the front panel, except LOCAL button.

Local control

***LOC** <cr>

This command activates the local control (using front panel buttons).

Local control lock

***LLO** <cr>

This command locks out the local control; the calibrator cannot be returned to local control by pressing LOCAL button. Return to local control can only be performed by a command sent through the bus, or by switching the calibrator off and on.

Local control unlock

***UNL** <cr>

This command cancels the „*LLO“ command. Unlocked calibrator can be returned to local control mode by pressing LOCAL button.

Examples of use

Calibration of measurement instruments

The calibrator can be used for direct calibration of various instruments which measure electrical values. Opt. 140-01 cable adapter is recommended. The cable adapter includes a temperature sensor which allows the measurement of external temperature. Measured value can be displayed by pressing INPUT button.

Multimeters

The calibrator can be used for calibration of digital and analogue multimeters (DCV, ACV, DCI, ACI, resistance, capacitance, temperature, frequency and duty cycle).

Voltage ranges

Thanks to low output impedance and high output current, the calibrator can be used for calibration of analogue voltmeters and millivoltmeters having low input impedance. Voltage output is connected to Hi/Lo terminals. The calibrator does not allow the four-wire connection of the instrument to be calibrated.

It is not recommended to connect non-standard load to the voltage output. The calibrator is designed to be used for calibration of voltmeters. Output terminals should be loaded with high and real impedance. Although the output is fitted with fast electronic and microprocessor protection, high capacitance or inductance loads can lead to oscillations of output amplifiers and result in damage.

The instrument to be calibrated can be connected directly to the front panel terminals. If L terminal of the instrument to be calibrated is not grounded, then calibrator's Lo terminal should be grounded (GND U ON, see „Setup menu“ chapter).

Connection of a multimeter to be calibrated (voltage range) to calibrator's output terminals

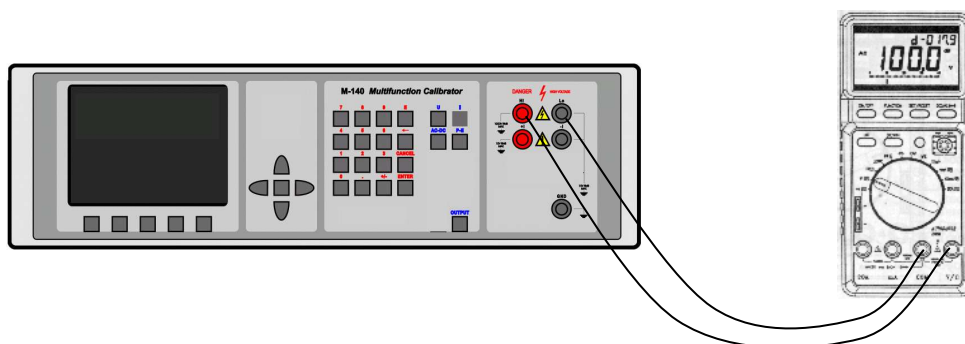

Current ranges

All DC and AC current ranges are connected to calibrator's +I/-I terminals.

When using the current output under heavy load (10 to 20 A), the runtime is limited to 0 to 60 s. The runtime depends on the set current and it is controlled by the microprocessor. The user cannot extend the runtime; if longer runtime is required, the output terminals must be unloaded, some time must elapse (for example 1 min.) and the load can then be connected again.

When feeding 2 to 20 A current to the output terminals, the output voltage must not exceed approx. 1.5 Vef. If the current induces higher voltage on the load, the calibrator disconnects the output terminals and displays an error message.

When ammeters are being calibrated using currents over 1 A, it is important to connect the terminals properly, paying attention both to the calibrator's output terminals and the instrument's input terminals. Excessive contact resistance can heat up the terminals and cause calibration errors. Excessive and unstable contact resistance has non-linear characteristic and can distort the output AC current.

It is not recommended to connect non-standard load to the current output. The calibrator is designed to be used for calibration of ammeters. Output terminals should be loaded with low and real impedance. Although the output is fitted with fast electronic and microprocessor protection, high capacitance or inductance can lead to oscillations of output amplifiers and result in damage.

The instrument to be calibrated can be connected directly to the front panel terminals. If L terminal of the instrument to be calibrated is not grounded, then calibrator's -U (-I) terminal should be grounded (GND U ON, GND I ON, see „Setup menu“ chapter).

Optional current coil can extend the calibrator's current range to 1000 A. The coil can be used for calibration of both DC and AC ammeters. The clamps of the ammeter must be positioned in angle 90° to the coil. When using the current coil, no steel or other magnetic objects must be present in the vicinity (50 cm) of the current coil, as they would deform the magnetic field and cause big calibration error.

Connection of current coil:

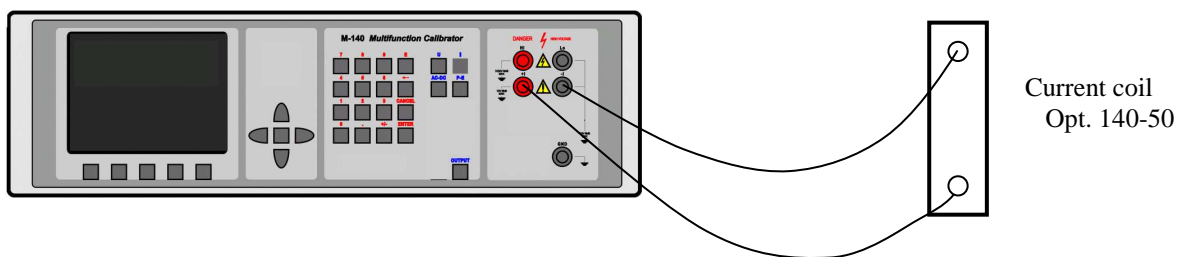

Thermometers

The calibrator can be used for calibration of transducers used in thermometers and heat meters, which use a thermocouple sensor. The block connected to the sensor is checked, as it is disconnected from the transducer and the calibrator's output is connected to the transducer's input instead. Simulation of thermal sensor is activated by pressing T direct mode button.

The calibrator can be connected to transducer's input directly from Hi/Lo terminals. Temperature of cold junction must be compensated by manual setting of RJ value. The connection is similar to voltmeter connection.

Specification

Uncertainties include long-term stability, temperature coefficient, linearity, load and line regulation and the traceability of factory and National calibration standards. Specified accuracy is valid after one hour warm up in temperature range $23 \pm 2^\circ\text{C}$. Specified accuracy is one year accuracy.

Calibrator

Voltage

summary range DCV:	0 μV – 1000 V
summary range ACV:	0.1 mV – 1000 V
internal ranges:	20 mV, 200 mV, 2 V, 20 V, 240 V, 1000 V
voltage resolution:	61/2 digit
frequency resolution:	6 digit, minimum step 0.001Hz
frequency range:	20 Hz to 100 kHz bellow 20 V 20 Hz to 10 kHz bellow 200 V 20 Hz to 1000 Hz bellow 1000 V

DCV uncertainty

Range	% value + μV	Max. current [mA]	Protection against external voltage [Vpk]
0 μV – 20.00000 mV	0.005 + 6	1	60
20.00000 mV – 200.0000 mV	0.0015 + 8	5	60
0.200000 mV – 2.000000 V	0.0012 + 10	30	60
2.00000 V – 20.00000 V	0.0010 + 50	30	60
20.0000 V – 240.0000 V	0.0015 + 500	30	350
240.000 V – 1000.000 V	0.005 + 20 000	2	1450

*² value of the range for uncertainty calculation is 200 V

ACV uncertainty

Range	% value + μV	Max. current [mA]	% value + % range	Max. current [mA]
	20 Hz - 10 kHz	20 Hz - 10 kHz	10 kHz - 50 kHz	10 kHz - 50 kHz
0.10000 mV – 20.00000 mV	0.2 + 30	0.5 * ³	0.20 + 0.10 + 20 μV	0.5 * ³
20.0000 mV – 200.0000 mV	0.1 + 80	4 * ³	0.15 + 0.05 + 20 μV	4 * ³
0.200000 mV – 2.000000 V	0.018 + 100	30	0.05 + 0.01	10
2.00000 V – 20.00000 V	0.018 + 1 000	30	0.05 + 0.03	10
20.0000 V – 240.0000 V * ²	0.018 + 10 000	30	--	--
240.000 V – 1000.000 V	0.03 + 200 000 * ¹	2	--	--

*¹ valid for $f < 1000$ Hz

*² value of the range for uncertainty calculation is 200 V, in the range 200 to 240 V is frequency limited to 1000 Hz.

*³ Output resistance < 0.1 Ohm. Minimum load resistance is 40 Ohm

Range	% value+ % range	Max. current [mA]	Protection against external voltage [Vpk]
	50 kHz - 100 kHz	50 kHz - 100 kHz	
0.10000 mV – 20.00000 mV	1.0 + 0.10 + 20 μV	0.5 * ²	60
20.0000 mV – 200.0000 mV	0.3 + 0.05 + 20 μV	2 * ²	60
0.200000 mV – 2.000000 V	0.2 + 0.05	5	60
2.00000 V – 20.00000 V	0.2 + 0.05	5	60
20.0000 V – 240.0000 V * ²	--	--	350
240.000 V – 1000.000 V	--	--	1450

Auxiliary parameters

Range	20mV	200mV	2V	20V	200V	1000V
THD * ¹	0,05% + 200 μV	0,05% + 300 μV	0,05%	0,05%	0,05%	0,2%
output impedance	< 10 m Ω	< 10 m Ω	< 10 m Ω	< 10 m Ω	< 100 m Ω	< 100 m Ω
maximal capacitance	800 pF	800 pF	30 nF	50 nF	10 nF	150 pF
load						

*¹ parameter includes non-linear distortion and non-harmonic noise

*2 valid for frequencies to 10 kHz

Function Shape

voltage range: 1 mV to 200 V
 wave form: square, positive, negative, symmetrical, ramp A, ramp B, triangle
 truncated sin with THD 13,45 %
 peak value uncertainty: 0.3 % + 50 uV
 displayed values: peak, effective
 Minimum frequency for squarewave signals is 0.1 Hz, for all other wave shapes 20 Hz.

Current

summary range DCI: 0 µA - 30 A (with current coil 140-50 to 1000A)
 summary range ACI: 1 µA - 30 A (with current coil 140-50 to 1000 A)
 internal ranges: 200 µA, 2 mA, 20 mA, 200 mA, 2 A, 30 A
 resolution: 6 1/2 digit
 frequency resolution: 6 digit, minimum step 0.001Hz
 frequency range: 20 Hz to 5 kHz bellow 200 mA
 20 Hz to 1000 Hz bellow 20 A
 40 Hz to 500 Hz in range 20 to 30 A

DCI uncertainty

Range	% value + µA	Min. compliance voltage [V]
0.0000 µA – 200.0000 µA	0.05 + 0.02	3
0.200000 mA – 2.000000 mA	0.02 + 0.1	3
2.000000 mA – 20.000000 mA	0.01 + 0.6	3
20.000000 mA – 200.000000 mA	0.01 + 6	3
0.200000 A – 2.000000 A	0.015 + 100	3
2.000000 A – 20.000000 A *1	0.02 + 2 000	1.5
20.000000 A – 30.000000 A *1	[0.02 + 0.003* (I-20)] + 2000 *3	0.5

ACI uncertainty

Range	% value + µA	Min. compliance voltage [Vrms]	% value + µA	Min. compliance voltage [Vrms]	% value + µA	Min. compliance voltage [Vrms]
	20 Hz - 1 kHz *2		1 kHz – 5 kHz		5 kHz – 10 kHz	
1.0000 µA – 200.0000 µA	0.15 + 0.02	3	0.30 + 0.22	3	--	--
0.200000 mA – 2.000000 mA	0.07 + 0.2	3	0.20 + 1	3	0.50 + 1.4	2
2.000000 mA – 20.000000 mA	0.05 + 1	3	0.20 + 10	3	0.50 + 14	2
20.000000 mA – 200.000000 mA	0.05 + 10	3	0.20 + 100	3	0.50 + 140	2
0.200000 A – 2.000000 A	0.05 + 100	3	--	--	--	--
2.000000 A – 20.000000 A *1	0.10 + 6000	1.5	--	--	--	--
20.000000 A – 30.000000 A *1	[0.1 + 0.003* (I-20)] + 6000 *3	0.5				

*1 Continuous current in range bellow 10 A. In range 10 to 30 A limited time to 60 s for current bellow 20 A and 30 s bellow 30 A.

*2 Frequency range for current 20 to 30 a is 40 Hz to 500 Hz

*3 I is set output current in [A]

When option 140-50 Current Coil is used, add uncertainty 0.3% of the set current to the value specified in above table. Output current is multiplied by factor 25 or 50 depending on applied coil range.

Auxiliary parameters

Range	200 uA	2 mA	20 mA	200 mA	2 A	20 A
maximal inductive load *1	1H	100 mH	100 mH	10 mH	1 mH	500 uH
THD *2	0,2%	0,2%	0,2%	0,2%	0,2%	0,3% *3

*1 DC and AC 50/60 Hz, voltage on the load < 2Vrms

*2 Parameter includes non-linear distortion and non-harmonic noise

*3 Distortion in range 20 to 30 A is max. 0.5%

Temperature sensors simulation

temperature scale:	ITS 90, PTS 68
type of sensor:	K, N, R, S, B, J, T, E
temperature range:	-250 to +1820 °C according to the type
temperature uncertainty:	0.4 to 4.3 °C (see the table below)
resolution:	0.1 °

Ranges and uncertainties of TC sensor simulation

R	range [°C]	-50 - 0	0 - 400	400 - 1000	1000 - 1767
	uncertainty [°C]	1.8 - 1.4	1.4 - 0.7	0.7 - 0.6	0.6 - 0.5
S	range [°C]	-50 - 0	0 - 250	250 - 1400	1400 - 1767
	uncertainty [°C]	1.6 - 1.3	1.3 - 0.8	0.8 - 0.6	0.7 - 0.6
B	range [°C]	400 - 800	800 - 1000	1000 - 1500	1500 - 1820
	uncertainty [°C]	1.7 - 0.9	0.9 - 0.8	0.8 - 0.7	0.7 - 0.6
J	range [°C]	-210 - -100	-100 - 150	150 - 700	700 - 1200
	uncertainty [°C]	0.3 - 0.2	0.2 - 0.1	0.2 - 0.1	0.2
T	range [°C]	-200 - -100	-100 - 0	0 - 100	100 - 400
	uncertainty [°C]	0.4 - 0.3	0.2	0.2	0.1
E	range [°C]	-250 - -100	-100 - 280	280 - 600	600 - 1000
	uncertainty [°C]	0.7 - 0.2	0.2 - 0.1	0.1	0.1
K	range [°C]	-200 - -100	-100 - 480	480 - 1000	1000 - 1372
	uncertainty [°C]	0.5 - 0.2	0.2	0.3 - 0.2	0.3
N	range [°C]	-200 - -100	-100 - 0	0 - 580	580 - 1300
	uncertainty [°C]	0.7 - 0.3	0.3	0.2	0.2

Uncertainties in the table show range of the uncertainties of TC sensor simulation in specified range. Actual uncertainty for each set value of simulated temperature is determined by uncertainty of relevant DC voltage. Actual temperature uncertainty is displayed on the calibrator display.

General data

Warm up time:	60 minutes
Reference temperature:	23 ± 2 °C
Range of working temperatures:	23 ± 10 °C
Temperature coefficient	Temperature coefficient for temperature outside of Tcal ±2 °C between +13 °C to +33 °C is 0.1 x /°C
Dimension:	450 x 480 x 150 mm
Power line:	115 - 220/230 V – 50/60 Hz
Power consumption:	45 VA without load Max. 150 VA with full load
Safety class:	I according EN 1010-1
Used external fuses:	F4L250V 1 pcs
Used internal fuses:	F1.6L250V 3 pcs
	F200mL250V 2 pcs
	F2.5L250V 2 pcs

Accessories

Basic accessories (included in delivery)

- Power line cord 1 pc
- Operation manual 1 pc
- Test report 1 pc
- Spare fuse 2 pc
- Test cable 1000V/30A, 1m 2 pc
- Cable RS RS-232 cable 1 pc

Options (extra ordered)

- 140-50 Current coil 50 turn
- Option 10 Output cable 30A/1000V (black)
- Option 11 Output cable 30A/1000V (red)
- WinQbase SW for calibration of instrument
- Caliber Program module for multimeters

Manufacturer

MEATEST, s.r.o.
Zelezna 509/3, 619 00 Brno
Czech Republic

tel: +420 – 543 250 886
fax: +420 – 543 250 890
meatest@meatest.cz
www.meatest.com